



**IP17/18**

# Pohištvo za gradbeništvo in industrijo

## INDUSTRIJA



## PISARNA



## MIZE / STOLI



## NASTANITEV





# KAZALO



## INDUSTRIJSKE OMARE / GARDEROBE od 4. strani

Garderobne omare / vrstne garderobne omare  
Z-omare  
Garderobe / večnamenske omare  
Predalni stolpi / ognjevarne omare  
Perforirane omare / garderobne kocke  
Skladiščni regali

INDUSTRIJA

## PISARNIŠKO POHIŠTVO od 22. str.

Omare s krilnimi vrati / regali  
Varnostne omare / omare za čistila/shranjevalni regal  
Pisarniške omare / omare z drsnimi vrati / omare z rolo vrati  
Ognjevarne omare / kotne mize  
Pisalne mize / predalniki na kolesih  
Kartotečne omare  
Univerzalni regali / vrtljiva stojala za registratorje

PISARNA

## MIZE / STOLI od 52. strani

Trapezne mize  
Konferenčne mize  
Večnamenske mize / mize za jedilnice  
Zložljive mize  
Vrtljivi stoli / stoli  
Garderobne klopi

MIZE /  
STOLI

## POHIŠTVO od 68. strani

Postelje  
Omare / pisalne mize  
Regali / komode  
Mize / obešala za oblačila  
Pogradi / vzmetnice  
Posteljnina / drugo

BIVANJE

## KUHINJA / DRUGO od 83. strani

Električne naprave

KUHINJA



## INDUSTRIJSKE OMARE / GARDEROBE

Garderobne omare / vrstne garderobne omare  
Z-omare  
Garderobe / večnamenske omare  
Predalni stolpi / ognjevarne omare  
Perforirane omare / garderobne kocke  
Skladiščni regali

INDUSTRIJA







SI. 253SM0101

## Garderobna omara Umazano / čisto



- Varjena izvedba na podnožju
- Prašno lakirana s strukturirano površino
- Vrata z okvirjem za etiketo, prezračevalnimi režami in zaklepom z vrtljivim zapahom za obežanko
- Na prekat 1 polica za klobuke z obežalnim drogom in 2 plastičnima obešaloma, nosilnost 7 kg

### Barve

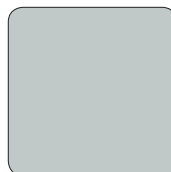

Standardna barva  
RAL7035 – svetlo  
siva



Barvne različice  
na koncu kataloga

### Podrobnosti



Okvir za etiketo



Vzmetni zapah



Vrtljivi zapah

### Dodatna oprema



Noge



Cilindrična  
ključavnica



Poševna streha

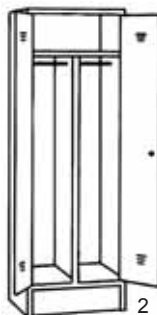
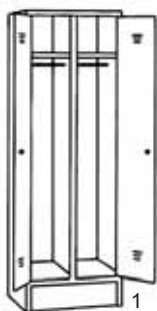

Komplet polic



Klop SB050C

Opis	Vrata	Vrtljivi zapah	Mere Š × G × V cm	Klop	Poševna streha	Komplet polic	Št. za naročilo
1 Garderobna omara	2	2	50 × 50 × 180	SB050C	DK050/01		253SM0101 
2 Garderobna omara	2	1	50 × 50 × 180	SB050C	DK050/01	FB025	52PSM0101 



Sl. 202SM0101

## Garderobna omara Umazano / čisto



- Varjena izvedba na podnožju
- Prašno lakirana s strukturirano površino
- Vrata z okvirjem za etiketo, prezračevalnimi režami in zaklepom z vrtljivim zapahom za obešanko
- Na prekat 1 polica za klobuke z obešalnim drogom in 2 plastičnima obešaloma, nosilnost 7 kg

### Barve

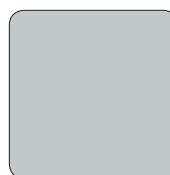

Standardna barva  
RAL7035 – svetlo  
siva



Barvne različice  
na koncu kataloga

### Podrobnosti



Okvir za etiketo



Vzmetni zapah



Vrtljivi zapah

### Dodatna oprema



Noge



Cilindrična  
ključavnica



Poševna streha

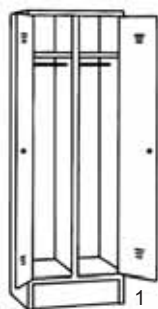

1

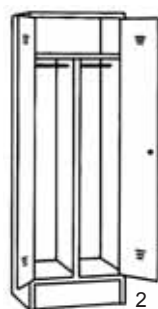

2

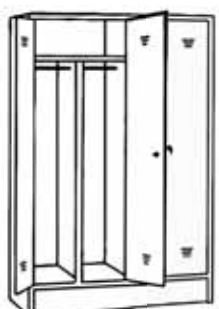



3



Komplet polic



Klop SB060C

Opis	Vrata	Vrtljivi zapah	Mere Š × G × V cm	Klop	Poševna streha	Komplet polic	Št. za naročilo
1 Garderobna omara	2	2	60 × 50 × 180	SB060C	DK060/01	FB30	202SM0101 
2 Garderobna omara	2	1	60 × 50 × 180	SB060C	DK060/01	FB30	21PSM0101 
3 Garderobna omara	4	2	120 × 50 × 180	SB120C	DK120/01		121SM0101

# Garderobna omara

Umazano / čisto



SI. 23PSM0101+FB040

- Varjena izvedba na podnožju
- Prašno lakirana s strukturirano površino
- Vrata z okvirjem za etiketo, prezračevalnimi režami in zaklepom z vrtljivim zapahom za obežanko
- Na prekat 1 polica za klobuke z obešalnim drogom in 2 plastičnima obešaloma, nosilnost 7 kg

## Barve

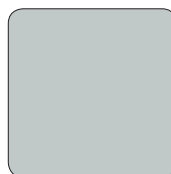

Standardna barva  
RAL7035 – svetlo  
siva



Barvne različice  
na koncu kataloga

## Podrobnosti



Okvir za etiketo



Vzmetni zapah



Vrtljivi zapah

## Dodatna oprema



Noge



Cilindrična  
ključavnica



Poševna streha



Komplet polic



Klop SB080C

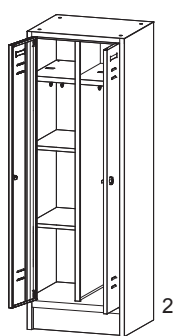
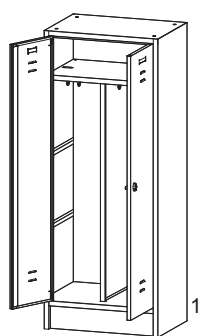

Opis	Vrata	Vrtljivi zapah	Mere Š × G × V cm	Klop	Poševna streha	Komplet polic	Št. za naročilo
1 Garderobna omara	2	1	80 × 50 × 180	SB080C	DK080/01	FB040	<b>24PSM0101</b>
2 Garderobna omara	2	2	80 × 50 × 180	SB080C	DK080/01	FB040	<b>23PSM0101</b>



## Vrstna garderobna omara

Umazano / čisto



Sl. K12SM0101

- Varjena izvedba na podnožju
- Prašno lakirana s strukturirano površino
- Vrata z okvirjem za etiketo, prezračevalnimi režami in zaklepom z vrtljivim zapahom za obešanko
- Na prekat 1 polica za klobuke z obešalnim drogom in 2 plastičnima obešaloma, nosilnost 7 kg
- Z eno pregradno steno na prekat
- Razdelitev na sredini

### Podrobnosti



Okvir za etiketo



Vzmetni zapah



Vrtljivi zapah

### Barve

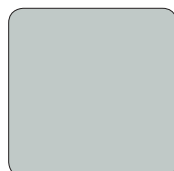

Standardna barva  
RAL7035 – svetlo  
siva



Barvne različice  
na koncu kataloga

### Dodatna oprema



Noge



Cilindrična  
ključavnica



Poševna streha



Klop SB080C



1

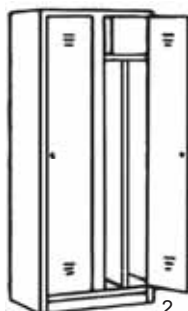

2

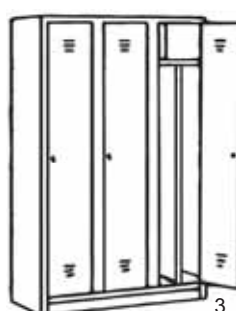

3

Opis	Vrata	Vrtljivi zapah	Mere Š × G × V cm	Klop	Poševna streha	Št. za naročilo
1 Garderobna omara	1	1	40 × 50 × 180	SB040C	DK040/01	<b>K41SM0101</b>
2 Garderobna omara	2	2	80 × 50 × 180	SB080C	DK080/01	<b>K82SM0101</b>
3 Garderobna omara	3	3	120 × 50 × 180	SB120C	DK120/01	<b>K12SM0101</b>

## Vrstna garderobna omara



Sl. 233SM0101

- Varjena izvedba na podnožju
- Prašno lakirana s strukturirano površino
- Vrata z okvirjem za etiketo, prezračevalnimi režami in zaklepom z vrtljivim zapahom za obešanko
- Na prekat 1 polica za klobuke z obešalnimi drogom in 2 plastičnima obešaloma, nosilnost 7 kg

### Barve

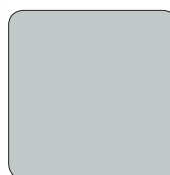

Standardna barva RAL7035 – svetlo siva



Barvne različice na koncu kataloga

### Podrobnosti



Okvir za etiketo



Vzmetni zapah



Vrtljivi zapah

### Dodatna oprema



Noge



Cilindrična ključavnica



Poševna streha



Klop SB060C

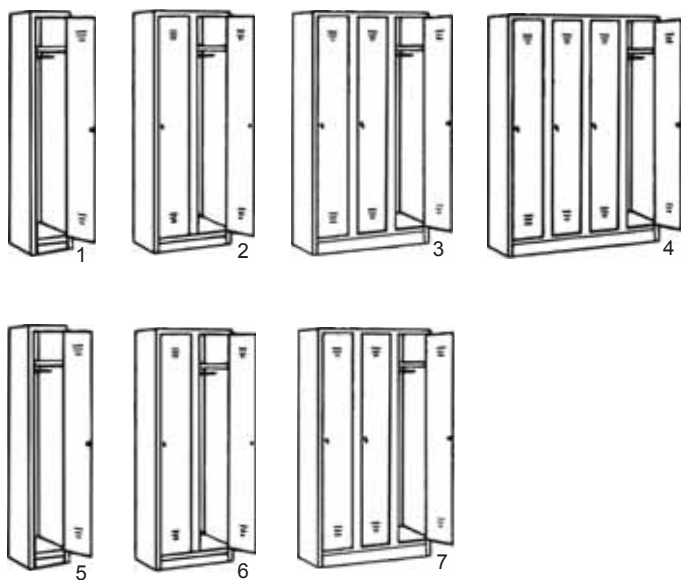

Opis	Vrata	Vrtljivi zapah	Mere Š × G × V cm	Klop	Poševna streha	Št. za naročilo
1 Garderobna omara	1	1	30 × 50 × 180	SB030C	DK030/01	<b>211SM0101</b>
2 Garderobna omara	2	2	60 × 50 × 180	SB060C	DK060/01	<b>212SM0101</b>
3 Garderobna omara	3	3	90 × 50 × 180	SB090C	DK090/01	<b>213SM0101</b>
4 Garderobna omara	4	4	120 × 50 × 180	SB120C	DK120/01	<b>214SM0101</b>
5 Garderobna omara	1	1	40 × 50 × 180	SB040C	DK040/01	<b>231SM0101</b>
6 Garderobna omara	2	2	80 × 50 × 180	SB080C	DK080/01	<b>232SM0101</b>
7 Garderobna omara	3	3	120 × 50 × 180	SB120C	DK120/01	<b>233SM0101</b>

## Seriya C



Sl. C3310101

- Varjena izvedba na podnožju
- Prašno lakirana s strukturirano površino
- Vrata z okvirjem za etiketo in zaklepom z vrtljivim zapahom za obešanko
- Intenzivno prezračevanje skozi ventilacijske luknje
- Na prekat 1 polica za klobuke z obešalnimi drogovi in 2 plastičnima obešaloma, nosilnost 7 kg, ter 2 polici
- Ojačana izvedba, debelina pločevine 0,7 mm

### Barve

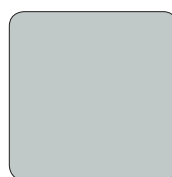

Standardna barva  
RAL7035 – svetlo  
siva

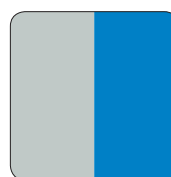

RAL7035 – svetlo  
siva / RAL5015 – nebeško  
modra



Barvne različice  
na koncu kataloga

### Podrobnosti



Obešalni drog



Okvir za etiketo



Vzmetni zapah



Vrtljivi zapah

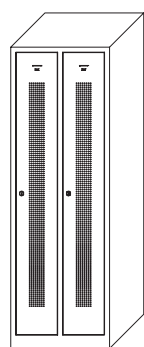

1

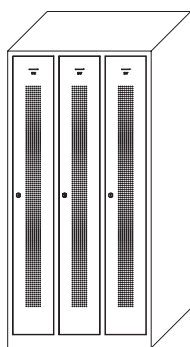

2

### Dodatna oprema

Cilindrična  
ključavnica

Klop SB060



Poševna streha

Opis	Vrata	Vrtljivi zapah	Mere Š × G × V cm	Klop	Poševna streha	Št. za naročilo
1 Garderobna omara	2	2	59 × 50 × 180	SB060	D0600	<b>C3210101</b> <b>C3210104, modra vrata</b>
2 Garderobna omara	3	3	87 × 50 × 180	SB090	D0900	<b>C3310101</b> <b>C3310104, modra vrata</b>

# Vrstna garderobna omara



Sl. 2080

- Robustna, varjena izvedba na podnožju
- Ojačana izvedba z debelino pločevine 0,7 mm
- Prašno lakirana s strukturirano površino
- Vrata, ojačana z zunaj ležečimi tečajji, držalo za imensko tablico in reža za pošto
- Razdelitev 2/3 in 1/3
- Intenzivno prezračevanje skozi ventilacijske luknje
- Zaklep z vrtljivim zapahom za obešanko
- Na prekat 1 polica za klobuke z obešalnim drogom in 2 obešaloma ter predelna stena

## Barve

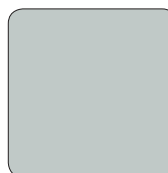

Standardna barva  
RAL7035 – svetlo siva

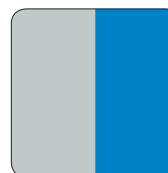

RAL7035 – svetlo siva / RAL5015 – nebeško modra



Barvne različice na koncu kataloga

## Podrobnosti



Reža za pošto



Tečaj od znotraj



Tečaj od zunaj



Vrtljivi zapah / ugreznjen ročaj

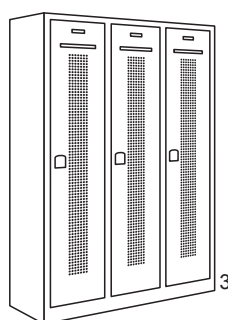
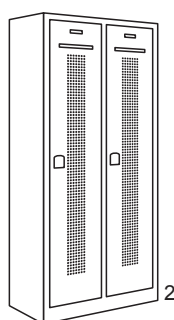
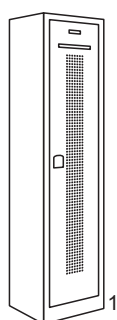

## Dodatna oprema



Cilindrična ključavnica



Poševna streha



Klop SB080

Opis	Vrata	Vrtljivi zapah	Mere Š × G × V cm	Klop	Poševna streha	Št. za naročilo
1 Garderobna omara	1	1	41,5 × 50 × 180	SB040	D0415	2040 2040T5015, modra vrata
2 Garderobna omara	2	2	80 × 50 × 180	SB080	D0800	2080 2080T5015, modra vrata
3 Garderobna omara	3	3	118,5 × 50 × 180	SB120	D1185	2120 2120T5015, modra vrata

## Z-omara



SI. Z800

- Varjena izvedba na podnožju
- Prašno lakirana s strukturirano površino
- Ojačana izvedba, debelina pločevine 0,7 mm
- Vrata z okvirjem za etiketo in zaklepom z vrtljivim zapahom za obešanko
- Intenzivno prezračevanje skozi ventilacijske luknje
- Na prekat 2 obešali za oblačila

### Barve

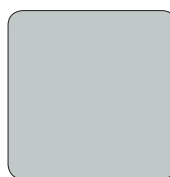

Standardna barva  
RAL7035 – svetlo  
siva

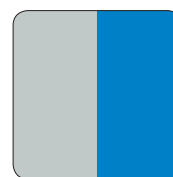

RAL7035 – svetlo  
siva / RAL5015 –  
nebeško modra



Barvne različice  
na koncu kataloga

### Podrobnosti



Obešala za  
oblačila



Tečaj od zunaj



Tečaj od znotraj

### Dodatna oprema



Cilindrična  
ključavnica

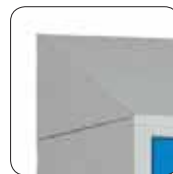

Poševna streha



Klop SB080

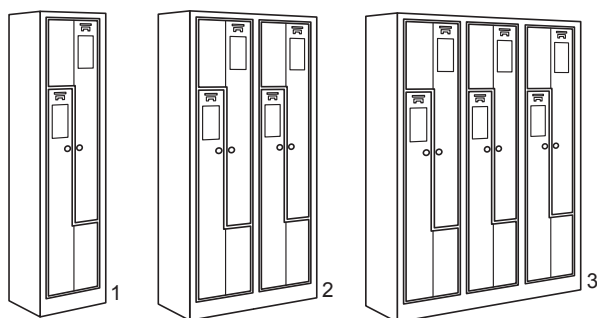

Opis	Vrata	Vrtljivi zapah	Mere Š × G × V cm	Klop	Poševna streha	Št. za naročilo
1 Garderobna omara	2	2	41,5 × 50 × 180	SB040	D0415	<b>Z415</b> <b>Z415T5015, modra vrata</b>
2 Garderobna omara	4	4	80 × 50 × 180	SB080	D0800	<b>Z800</b> <b>Z800T5015, modra vrata</b>
3 Garderobna omara	6	6	120 × 50 × 180	SB120	D1185	<b>Z120</b> <b>Z120T5015, modra vrata</b>



## Garderoba

- Varjena izvedba na podnožju
- Prašno lakirana s strukturirano površino
- Vrata z okvirjem za etiketo in zaklepom z vrtljivim zapahom za obešanko
- 2 odlagalni polici, 1 obešalni drog

### Barve



Standardna barva  
RAL7035 – svetlo  
siva



Barvne različice  
na koncu kataloga

### Podrobnosti



Okvir za etiketo

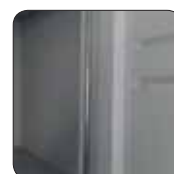

Navpične palice



Vrtljivi zapah

### Dodatna oprema



Cilindrična  
ključavnica



SI. 910SM0104



1

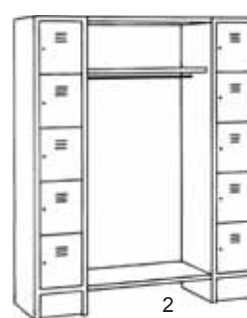

2

Opis	Vrata	Mere predalov v cm	Mere Š × G × V cm	Št. za naročilo
1 Garderoba	5	26 × 29	122 × 50 × 180	<b>905SM0101</b>
2 Garderoba	10	26 × 29	154 × 50 × 180	<b>910SM0101</b>

## Večnamenska omara



SI. 274SM0101

- Varjena izvedba na podnožju
- Prašno lakirana s strukturirano površino
- Vrata z okvirjem za etiketo in zaklepom z vrtljivim zapahom za obežanko
- Na vrsto 2 obešalna droga s 4 obešali

### Barve



Standardna barva  
RAL7035 – svetlo  
siva



Barvne različice  
na koncu kataloga

### Podrobnosti



Okvir za etiketo



Navpične palice



Vrtljivi zapah

### Dodatna oprema



Cilindrična  
ključavnica



Klop SB070C

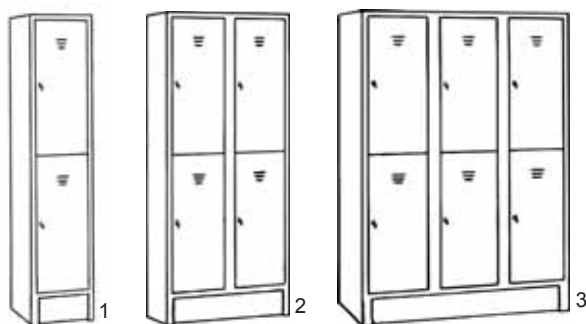

Opis	Vrata	Mere predalov v cm	Mere Š × G × V cm	Klop	Št. za naročilo
1 Omara	2	26 × 76	35 × 50 × 180	SB035C	<b>272SM0101</b>
2 Omara	4	26 × 76	70 × 50 × 180	SB070C	<b>274SM0101</b>
3 Omara	6	26 × 76	105 × 50 × 180	SB105C	<b>276SM0101</b>

## Predalni stolp

- Varjena izvedba na podnožju
- Prašno lakirana s strukturirano površino
- Vrata z okvirjem za etiketo in zaklepom z vrtljivim zapahom za obešanko



Sl. S15SM0101

Sl. S10SM0101

### Barve

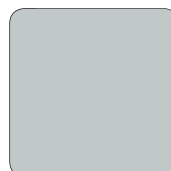

Standardna barva  
RAL7035 – svetlo  
siva



Barvne različice  
na koncu kataloga

### Podrobnosti



Okvir za etiketo



Navpične palice



Vrtljivi zapah



### Dodatna oprema



Cilindrična  
ključavnica



Klop SB070C

Opis	Vrata	Mere predalov v cm	Mere Š × G × V cm	Klop	Št. za naročilo
1 Predalni stolp	5	26 × 29	35 × 50 × 180	SB035C	<b>S05SM0101</b>
2 Predalni stolp	10	26 × 29	70 × 50 × 180	SB070C	<b>S10SM0101</b>
3 Predalni stolp	15	26 × 29	105 × 50 × 180	SB105C	<b>S15SM0101</b>

## Predalni stolp

- Varjena izvedba na podnožju
- Prašno lakirana s strukturirano površino
- Vrata z okvirjem za etiketo in zaklepom z vrtljivim zapahom za obešanko



SI. S08SM0101

SI. S04SM0101

### Barve



Standardna barva  
RAL7035 – svetlo  
siva



Barvne različice  
na koncu kataloga

### Podrobnosti



Okvir za etiketo



Navpične palice



Vrtljivi zapah

### Dodatna oprema



Cilindrična  
ključavnica



Klop SB070C

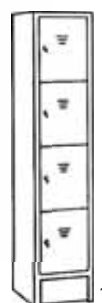

1

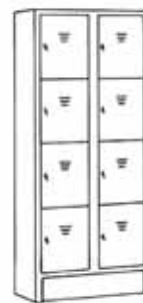

2

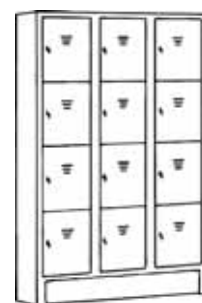

3

Opis	Vrata	Mere predalov v cm	Mere Š × G × V cm	Klop	Št. za naročilo
1 Predalni stolp	4	26 × 37	35 × 50 × 180	SB035C	<b>S04SM0101</b>
2 Predalni stolp	8	26 × 37	70 × 50 × 180	SB070C	<b>S08SM0101</b>
3 Predalni stolp	12	26 × 37	105 × 50 × 180	SB105C	<b>S12SM0101</b>

## Ognjevarna omara

- Robustna, varjena izvedba na podnožju
- Prašno lakirana, barva RAL3000, ognjeno rdeče barve s strukturirano površino
- Na prekat 1 obešalni drog s 3 obešali in dodatno 2 obešali na stranicah
- Držalo za čelado

### Barva



Standardna barva RAL3000 – ognjeno rdeča

### Podrobnosti



Držalo za čelado  
Plastika, bela

### Dodatna oprema



SI. FST4ZY



SI. FWT4ZY



SI. FFS



SI. F080

SI. F080 z vsemi možnostmi

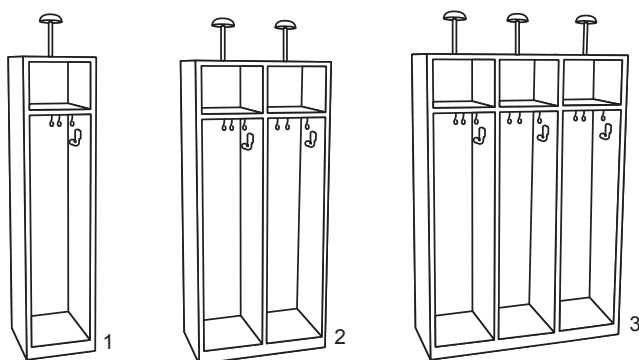

Opis	Prekati	Mere Š × G × V cm	Večja vrata	Manjša vrata	Komplet nog	Št. za naročilo
1 Ognjevarna omara	1	41,5 × 50 × 180	FST4 vrtljivi zapah FST4ZY cilindrična ključavnica	FWT4 vrtljivi zapah FWT4ZY cilindrična ključavnica	FFS	<b>F040</b>
2 Ognjevarna omara	2	80 × 50 × 180	FST4 vrtljivi zapah FST4ZY cilindrična ključavnica	FWT4 vrtljivi zapah FWT4ZY cilindrična ključavnica	FFS	<b>F080</b>
3 Ognjevarna omara	3	118,5 × 50 × 180	FST4 vrtljivi zapah FST4ZY cilindrična ključavnica	FWT4 vrtljivi zapah FWT4ZY cilindrična ključavnica	FFS	<b>F120</b>





Sl. DCH18022

## Perforirana omara

- Mrežasta omara
- Preprost nadzor za preprečitev kraja
- Optimalno prezračevanje delovnih oblačil
- Robustna konstrukcija iz jeklene pločevine, prašno lakirana s strukturirano površino
- Varjena perforirana pločevina z okroglimi luknjami
- Zaklep z vrtljivim kovinskim zapahom za obešanko
- Dobavljena sestavljena

### Barve

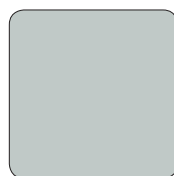

Standardna barva  
RAL7035 – svetlo  
siva



Barvne različice  
na koncu kataloga

### Podrobnosti



Obešala za  
oblačila



Vzmetni zapah

### Dodatna oprema



Cilindrična  
ključavnica



1

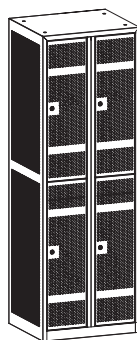

2

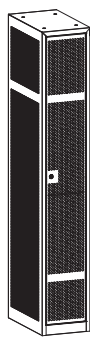

3

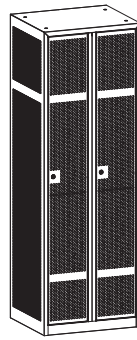

4

Opis	Vrste	Vrata	Mere Š × G × V cm	Št. za naročilo
1 Perforirana omara	1	2	30 × 30 × 180	DCH18012
2 Perforirana omara	2	4	60 × 30 × 180	DCH18024
3 Perforirana omara	1	1	30 × 30 × 180	DCH18011
4 Perforirana omara	2	2	60 × 30 × 180	DCH18022

# Garderobna kocka



Sl. CB11/7035

- Prašno lakirana s strukturirano površino
- Gladka prednja površina, saj se zahvaljujoč tečajem od znotraj površina vrat poravna z ogrodjem omare
- Ročaj iz umetne mase s cilindrično ključavnico in 2 ključema
- Optimalno prezračevanje skozi ventilacijske odprtine v vsakem predalu
- Poljubna razširitev
- Stranske odprtine za lažje medsebojno povezovanje

## Barve

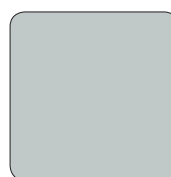

Standardna barva  
RAL7035 – svetlo  
siva



Barvne različice  
na koncu kataloga

## Dodatna oprema







Podnožje

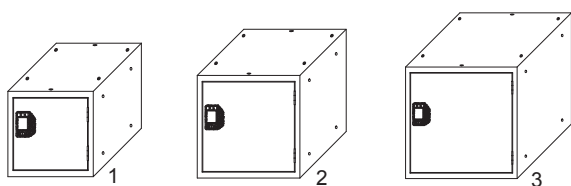

Sl. Barvne možnosti

## Podrobnosti



Opis	Mere Š × G × V cm	Podnožje v cm	Podnožje	Št. za naročilo
1 Garderobne kocke	30,5 × 30,5 × 30,5	30,3 × 29,4 × 8	CBS30	<b>CB10/7035</b> – vrata v standardni barvi <b>CB10T5010</b> – modra vrata  <b>CB10T3000</b> – rdeča vrata <b>CB10T7016</b> – antracitna vrata
2 Garderobne kocke	38,1 × 38,1 × 38,1	37,9 × 37 × 8	CBS38	<b>CB11/7035</b> – vrata v standardni barvi <b>CB11T5010</b> – modra vrata  <b>CB11T3000</b> – rdeča vrata <b>CB11T7016</b> – antracitna vrata
3 Garderobne kocke	45 × 45 × 45	44,8 × 43,9 × 8	CBS45	<b>CB12/7035</b> – vrata v standardni barvi <b>CB12T5010</b> – modra vrata  <b>CB12T3000</b> – rdeča vrata <b>CB12T7016</b> – antracitna vrata

## Skladiščni regal



SI. 2845ZG

- Certificiran po UNI EN 10147, UNI EN 10149, UNI EN 10204
- Varnost preizkušena s strani inštituta TÜV
- Ogrodje in nosilci iz stabilnih kovinskih profilov, popolnoma pocinkani
- Dobavljeno razstavljeno, preprosta in hitra samostojna montaža
- Po želji 4 ali 5 polic
- Stranici predhodno montirani

## Barva



Standardna barva

## Podrobnosti



Police, stranske stene





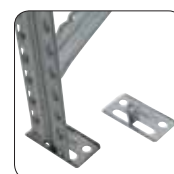

Pokrovi

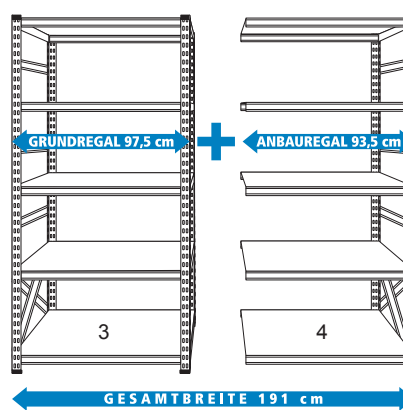
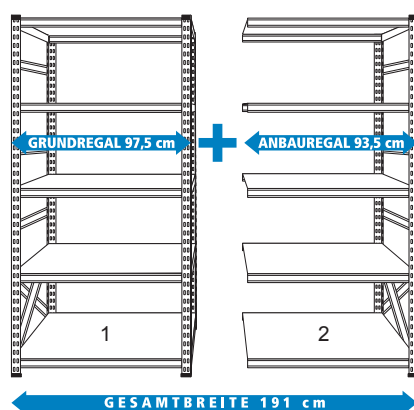

Pritrditev v tla



Opis	Nosilnost police / polja v kg	Mere Š × G × V cm	Polica	Št. za naročilo
1 Osnovni regal	235/1500	97,5 × 40 × 200	FB040Z	2844ZG – 4 police 2845ZG – 5 polic 
2 Priključni regal	235/1500	93,5 × 40 × 200	FB040Z	2844ZA – 4 police 2845ZA – 5 polic 
3 Osnovni regal	185/1500	97,5 × 50 × 200	FB050Z	2854ZG – 4 police 2855ZG – 5 polic 
4 Priključni regal	185/1500	93,5 × 50 × 200	FB050Z	2854ZA – 4 police 2855ZA – 5 polic 



## PISARNIŠKO POHIŠTVO

Omare s krilnimi vrati / regali  
Varnostne omare / omare za čistila / shranjevalni regal  
Pisarniške omare / omare z drsnimi vrati / omare z rolo vrati  
Ognjevarne omare / kotne mize  
Pisalne mize / predalniki na kolesih  
Kartotečne omare  
Univerzalni regali / vrtljiva stojala za registratorje

PISARNA







## Omara s krilnimi vrati

- Univerzalna omara, primerna za arhiv in pisarno
- Kombinirano odlagališče za registratorje in obešalne mape v eni omari
- 180° odpiranje vrat
- 4 nastavljive police, 5 višin za registratorje
- Zaklep na vrtljivo cilindrično ključavnico s 3-točkovnim zapiralom
- Zahvaljujoč tečajem od znotraj se vrata poravnajo s površino ogrodja omare
- Prašno lakirana s strukturirano površino
- Regali z zadnjo steno

### Dodatna oprema



Ključavnica



Polica



Glavni ključ



Sl. 2297



### Barve

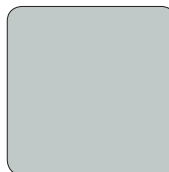

Standardna barva  
RAL7035 – svetlo  
siva

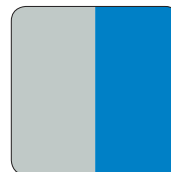

RAL7035 – svetlo siva  
/ RAL5015 – nebeško  
modra



Barvne različice na  
koncu kataloga

### Podrobnosti



Obešalne mape



3-točkovno  
zapiralo



Mreža za  
obešanje 3,5 cm







Odpiranje vrat

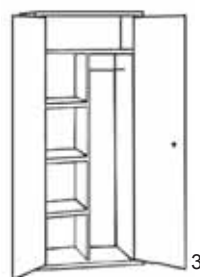

Tečaj od znotraj



Opis	Vrata	Police	Notranji prostor	Mere Š × G × V cm	Polica	Št. za naročilo
1 Univerzalna omara	2	4	-	92 × 42 × 195	FB2297	<b>2297</b> – siva / siva <b>2297T5015</b> – modra vrata 
2 Univerzalna omara, pocinkana	2	4	-	92 × 42 × 195	FB2297VZ	<b>2297VZ</b> <b>2297T50VZ</b> – modra vrata 
3 Omara za oblačila / dokumente	2	3	1 zgornja polica, 1 obešalni drog	92 × 42 × 195		<b>2297AK</b> 
4 Univerzalni regal	-	4	z zadnjo steno	92 × 42 × 195	FB2297	<b>2297/0</b> 

## Omara s krilnimi vrati



Sl. 2296

- Kombinirano odlagališče za registratorje in obešalne mape v eni omari
- Prašno lakirana s strukturirano površino
- Zaklep na vrtljivo cilindrično ključavnico z 2-točkovnim zapiralom
- Zahvaljujoč tečajem od znotraj se vrata poravnajo s površino ogrodja omare
- Regali z zadnjo steno



Sl. 2295/0

### Barve

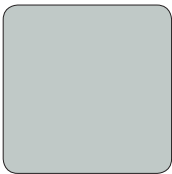

Standardna barva  
RAL7035 – svetlo  
siva



Barvne različice  
na koncu kataloga

### Podrobnosti



Obešalne mape  
in registratorji



2-točkovno  
zapiralo



Mreža za  
obešanje 3,5 cm

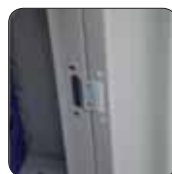

Tečaj od znotraj





Višine za  
registratorje

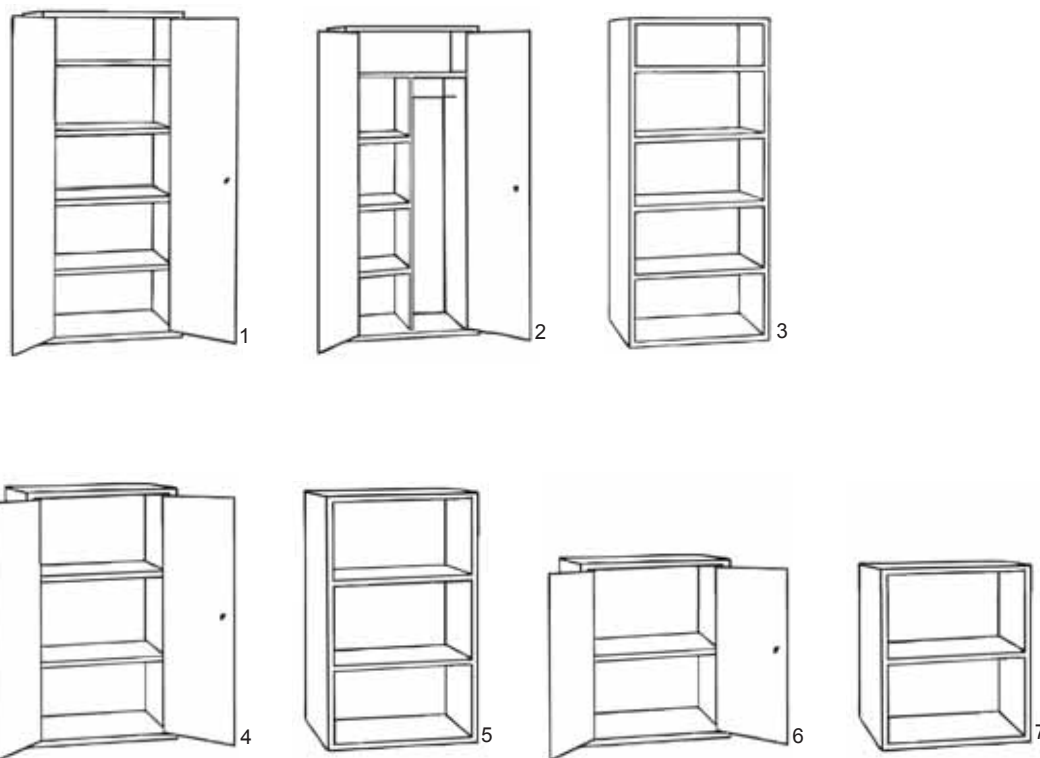

Vzmetni zapah pri  
2296



Opis	Vrata	Police	Notranji prostor	Mere Š × G × V cm	Št. za naročilo
1 Omara za dokumente	2	4	4,5 višine za registratorje	80 × 38 × 180	2296 
2 Omara za oblačila / omara za dokumente	2	3	1 zgornja polica, 1 obešalni drog	80 × 38 × 180	2296AK 
3 Regal za dokumente	-	4	4,5 višine za registratorje	80 × 38 × 180	2296/0 
4 Omara za dokumente	2	2	3 višine za registratorje	80 × 38 × 120	2295 
5 Regal za dokumente	-	2	3 višine za registratorje	80 × 38 × 120	2295/0 
6 Omara za dokumente	2	1	2 višini za registratorje	80 × 38 × 75	2294
7 Regal za dokumente	-	1	2 višini za registratorje	80 × 38 × 75	2294/0

Opis	Polica
1 Omara za dokumente	FB2296
2 Omara za oblačila / omara za dokumente	-
3 Regal za dokumente	FB2296
4 Omara za dokumente	FB2296
5 Regal za dokumente	FB2296
6 Omara za dokumente	FB2296
7 Regal za dokumente	FB2296

#### Dodatna oprema



Ključavnica



Polica



Glavni ključ



Sl. 2292

## Omara s krilnimi vrati



- Univerzalna omara, primerna za arhiv in pisarno
- Kombinirano odlagališče za registratorje in obešalne mape v eni omari
- 180° odpiranje vrat
- 4 nastavljive police, 5 višin za registratorje
- Zaklep na vrtljivo cilindrično ključavnico z 2-točkovnim zapiralom
- Zahvaljujoč tečajem od znotraj se vrata poravnajo s površino ogrodja omare
- Prašno lakirana s strukturirano površino
- Regali z zadnjo steno

### Barve

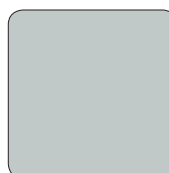

Standardna barva  
RAL7035 – svetlo  
siva



Barvne različice  
na koncu kataloga

### Podrobnosti



Obešalne mape  
in registratorji



2-točkovno  
zapiralo



Mreža za obešanje  
Razmik 3,5 cm



Odpiranje vrat



Tečaj od znotraj



### Dodatna oprema



Ključavnica



Polica



Glavni ključ

Opis	Vrata	Notranji prostor	Mere Š × G × V cm	Polica	Št. za naročilo
1 Univerzalna omara	2	-	120 × 42 × 195	FB2290	<b>2290/0101</b>
2 Univerzalni regal	-	z zadnjo steno	120 × 42 × 195	FB2290	<b>2290/0/01</b>
3 Univerzalna omara	2	-	92 × 50 × 195	FB2292	<b>2292</b>
4 Univerzalni regal	-	z zadnjo steno	92 × 50 × 195	FB2292	<b>2292/0</b>
5 Univerzalna omara	2	-	92 × 60 × 195	FB2292/60	<b>2292/60</b>



SI. US92/0101

## Omara za kemikalije

- Za skladiščenje majhnih posod s snovmi, ki ogrožajo vodo, omejeno na manj kot 100 l/omara
- Ni primerno za skladiščenje vnetljivih snovi
- Zaklep na vrtljivo cilindrično ključavnico z 2-točkovnim zapiralom
- Prašno lakirana s strukturirano površino
- Krilna vrata s 180° odpiranjem, zgoraj in spodaj s prezračevalnimi odprtini
- Vrata so iz notranje strani ojačana ter opremljena z žepki za navodila za uporabo, opozorila o nevarnostih itd.
- Kadi je možno nastavljati po 3-centimetrski mreži
- 2 vrata, 4 pocinkane kadi
- Prostornina 3 × 20 litrov + 1 × 40 litrov
- Nosilnost na kad: 80 kg



SI. 2293

## Omara za čistila

- Robustna, varjena izvedba na podnožju
- Prašno lakirana s strukturirano površino
- Zaklep na vrtljivo cilindrično ključavnico z 2-točkovnim zapiralom
- 1 trdna polica za klobuke
- 180° odpiranje vrat
- Zahvaljujoč tečajem od znotraj se vrata poravnajo s površino ogrodja omare
- Dvojna vrata
- 1 vrtljiva cilindrična ključavnica
- 3 majhne police
- 1 obešalni drog

### Podrobnosti



2-točkovno zapiralo



Odpiranje vrat



Tečaj od znotraj



Ključavnica

### Dodatna oprema

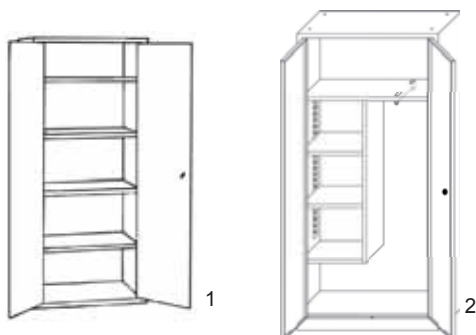

Opis	Mere Š × G × V cm	Št. za naročilo
1 Omara za kemikalije	92 × 50 × 195	US92/0101
2 Omara za čistila	92 × 42 × 195	2293

### Barve

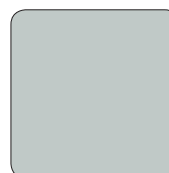
Standardna barva  
RAL7035 – svetlo siva





Sl. 2297 / PLAN

## Shranjevalni regal

- Prašno lakirana s strukturirano površino
  - Regali z zadnjo steno
  - Razdelilnik polic je v celoti varjen
  - 2 veliki odlagalni polici, 18 manjših polic
- Mere predalov:
    - 1. velika odlagalna polica (zgoraj):  
86 × 39 cm
    - 2. velika odlagalna polica (spodaj):  
86 × 40,5 cm
    - manjše police:  
2 × Š: 30,5 cm; 2 × V: 17,5 cm (levo zunaj / sredina)
    - 1 × Š: 29,0 cm; 1 × V: 17,5 cm (desno zunaj)

### Barva

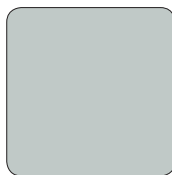

Standardna barva  
RAL7035 – svetlo siva

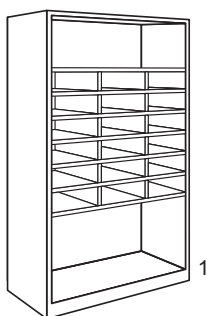

Opis	Mere Š × G × V cm	Št. za naročilo
1 Shranjevalni regal	92 × 42 × 195	2297 / PLAN



SI. SR80OH5GR, ST80OH5GR

## Lesena pisarniška omara

- Stranice / vrata debeline 18 mm z robnim trakom debeline 2 mm
- Zadnja stena regalov debeline 8 mm, utorjena z zadnjim panelom, zato jo je mogoče uporabiti kot predelno steno
- Zgornji in spodnji del ter polica debeline 25 mm z robnim trakom debeline 2 mm
- Okovje in tečaji v stabilni kovinski izvedbi
- Nastavljive noge je mogoče nastavljati z notranje strani
- Kovinska cilindrična ključavnica z 2 zložljivima ključema
- Dobavljeno razstavljeno, preprosta in hitra samostojna montaža

### Barve

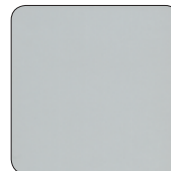

Standardni dekor siva



Standardni dekor javor

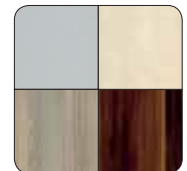

Barvne različice na koncu kataloga

### Podrobnosti



Ročaj



Tečaj od znotraj



Ključavnica

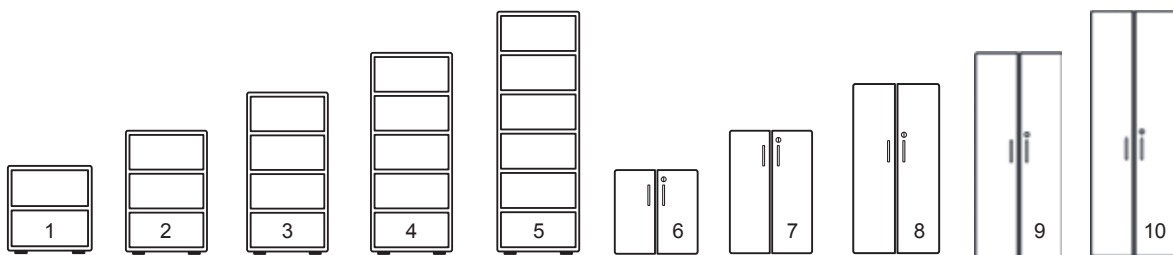

Opis	Višine za registratorje	Mere Š × V × G cm	Št. za naročilo – siva	Št. za naročilo – javor
1 Regal	2	80 × 74 × 37,5	SR80OH2GR	SR80OH2AH
2 Regal	3	80 × 109,5 × 37,5	SR80OH3GR	SR80OH3AH
3 Regal	4	80 × 144,5 × 37,5	SR80OH4GR	SR80OH4AH
4 Regal	5	80 × 180 × 37,5	SR80OH5GR	SR80OH5AH
5 Regal	6	80 × 215 × 37,5	SR80OH6GR	SR80OH6AH
6 Vrata za št. naročila SR80OH2	2	80 × 74 × 37,5	ST80OH2GR	ST80OH2AH
7 Vrata za št. naročila SR80OH3	3	80 × 109,5 × 37,5	ST80OH3GR	ST80OH3AH
8 Vrata za št. naročila SR80OH4	4	80 × 144,5 × 37,5	ST80OH4GR	ST80OH4AH
9 Vrata za št. naročila SR80OH5	5	80 × 180 × 37,5	ST80OH5GR	ST80OH5AH
10 Vrata za št. naročila SR80OH6	6	80 × 215 × 37,5	ST80OH6GR	ST80OH6AH

## Lesena omara z drsnimi vrati



SI. SSOH3AH

- Stranice / vrata debeline 18 mm z robnim trakom debeline 2 mm
- Zadnje stene debeline 8 mm, utorjene z zadnjim panelom, zato jih je mogoče uporabiti kot predelno steno
- Zgornji in spodnji del ter polica debeline 25 mm z robnim trakom debeline 2 mm
- Okovje in tečaji v stabilni kovinski izvedbi
- Nastavljive noge je mogoče nastavljati z notranje strani
- Kovinska cilindrična ključavnica z 2 zložljivima ključema

### Barve

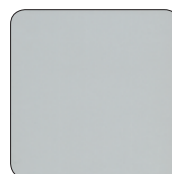

Standardni dekor  
siva



Standardni dekor  
javor

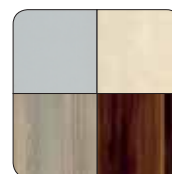

Barvne različice  
na koncu kataloga



SI. SSOH2GR

### Podrobnosti



Ročaj



Ključavnica

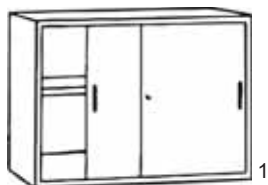

Opis	Višine za registratorje	Mere Š × G × V cm	Št. za naročilo – siva	Št. za naročilo – javor
1 Omara z drsnimi vrati	2	120 × 40 × 74	SSOH2GR	SSOH2AH
2 Omara z drsnimi vrati	3	120 × 40 × 109,5	SSOH3GR	SSOH3AH

## Omara z drsnimi vrati



SI. ST3D01

- Robustna jeklena izvedba
- Prašno lakirana s strukturirano površino
- Drsna vrata z vgrajenim ugreznjenim ročajem
- Potisna cilindrična ključavnica z 2 zložljivima ključema
- Regali z zadnjo steno

### Barva

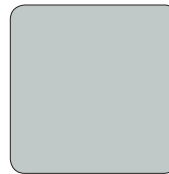

Standardna barva  
RAL7035 – svetlo  
siva

### Podrobnosti



Ročaj



Ključavnica



Mreža za obešanje  
Razmik 3,5 cm

### Dodatna oprema



Polica



SI. ST2D01

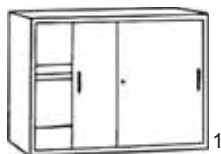

1

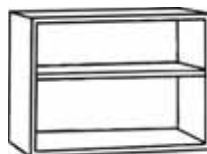

2



3



4

Opis	Police	Višine za registratorje	Mere Š × G × V cm	Polica	Št. za naročilo
1 Omara z drsnimi vrati	1	2	120 × 42 × 75	FBSTS01	<b>ST2D01</b>
2 Regali z zadnjo steno	1	2	120 × 42 × 75	FBSTS01	<b>ST2/0/01</b>
3 Omara z drsnimi vrati	2	3	120 × 42 × 108	FBSTS01	<b>ST3D01</b>
4 Regali z zadnjo steno	2	3	120 × 42 × 108	FBSTS01	<b>ST3/0/01</b>

## Omara z rolo vrati



SI. RS05/7035

SI. RS02/7035

- Robustna, varjena izvedba
- Prašno lakirana s strukturirano površino
- Omare z rolo vrati iz profilov iz umetne mase z vgrajenim ugreznjenim ročajem
- Cilindrična ključavnica z 2 zložljivima ključema
- Ohišje iz jeklene pločevine
- Varjena omara z rolo vrati

### Barve

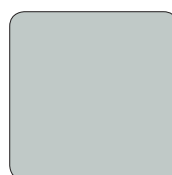

Standardna barva  
RAL7035 – svetlo  
siva



RAL9005 –  
intenzivno črna

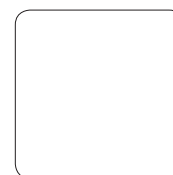

RAL9003 –  
signalno bela

### Podrobnosti



Dršno vodilo



Nosilci polic



Obešalne mape



Ključavnica

### Dodatna oprema



Polica

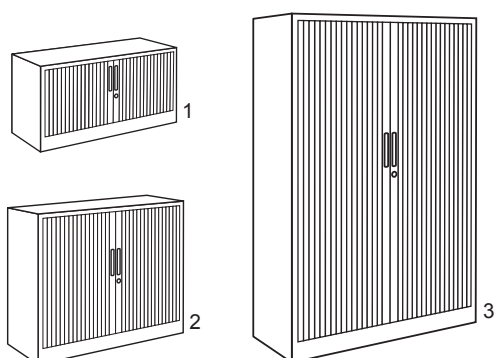

Opis	Predali	Višine za registratorje	Mere Š × G × V cm	Polica	Št. za naročilo – siva	Št. za naročilo – črna	Št. za naročilo – signalno bela
1 Omara z rolo vrati	1	1,5	120 × 42 × 75	FBRS/7035	<b>RS02/7035</b>	<b>RS02/9005</b>	<b>RS02/9003</b>
2 Omara z rolo vrati	2	2,5	120 × 42 × 105	FBRS/7035	<b>RS03/7035</b>	<b>RS03/9005</b>	<b>RS03/9003</b>
3 Omara z rolo vrati	4	5	120 × 42 × 195	FBRS/7035	<b>RS05/7035</b>	<b>RS05/9005</b>	<b>RS05/9003</b>





Sl. SD01/1601

## Ognjevarna omara za dokumente

- Dvojna stena na vseh straneh
- Med stenami so plasti iz kamene volne debeline 30 cm
- Negorljivo, zaščita pred manjšimi požari ter poizkusi vloma
- Krilna vrata zgoraj in spodaj na stabilnih vrtljivih sornikih, protivlomna zaščita z vratnim varovalom na stranicah
- Zaklepni sistem s 5 sorniki (ob straneh trije, zgoraj / spodaj po en sornik)
- Posebna ključavnica z 2 ključema
- Debelina jekla 1 mm
- Kakovost jekla CCR1110
- Vrata se odpirajo v obe smeri do 180°
- Elektrostatični in proti praskam odporni epoksidni praškasti premaz
- 4 po višini nastavljive montažne police

### Barva



Standardna barva  
RAL7021 – črno-siva /  
RAL7035 – svetlo siva

### Podrobnosti



Ognjevarna guma



Varnostna ključavnica



Tečaj od zunaj



Odpiranje vrat



Sornik vrat

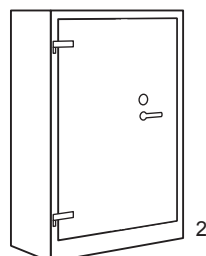
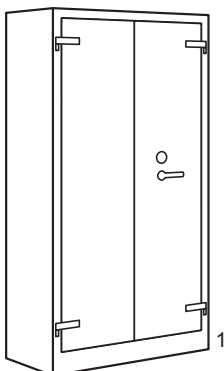

### Dodatna oprema



Slepi ključ

Opis	Število vrat	Število polic	Teža	Mere Š × G × V cm	Barve	Št. za naročilo
1 Omara za dokumente	2	4	pribl. 171 kg	95 × 55 × 195	Glavni del: črno-siva Vrata: svetlo siva	<b>SD01/1601</b>
2 Omara za dokumente	1	3	pribl. 113 kg	70 × 55 × 150	Glavni del: črno-siva Vrata: svetlo siva	<b>SD02/1601</b>



SI. HP1812RGR

## Miza prostih oblik

- Mizna plošča debeline 25 mm z robnim trakom debeline 2 mm
- 2 odprtini za kable
- Prašno lakirano T-podnožje aluminijasto-srebrne strukture
- Noge z višinsko nastavljivimi talnimi drsniki
- Dobavljeno razstavljeno, preprosta in hitra samostojna montaža

### Barve



Standardni dekor siva



Standardni dekor javor

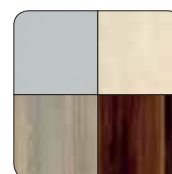

Barvne različice na koncu kataloga

### Podrobnosti



Preboj za kablel

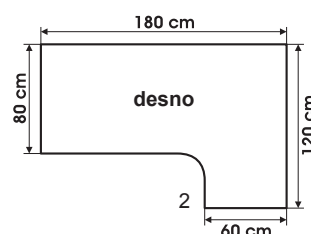
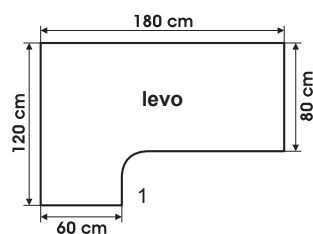

Opis	Mere Š × G × V cm	Št. za naročilo – siva	Št. za naročilo – javor
1 Miza prostih oblik	180 × 120 × 80 × 73	HP1812LGR	HP1812LAH
2 Miza prostih oblik	180 × 120 × 80 × 73	HP1812RGR	HP1812RAH



SI. WK7120200  
DRC2/0303  
DRC3/0303

## Kotna miza

- Mizna plošča debeline 25 mm, z robnim trakom debeline 2 mm, odporna proti praskam, skladno s kakovostjo DIN EN14322:2004+06
- Jekleni okvir, prašno lakiran s strukturirano površino
- Noge z višinsko nastavljivimi talnimi drsniki (15 mm)
- Dobavljeno razstavljeno, preprosta in hitra samostojna montaža

### Barve

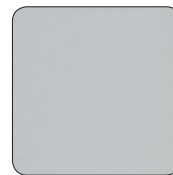

Standardni dekor  
siva



Standardni dekor  
javor



Barvne različice  
na koncu kataloga

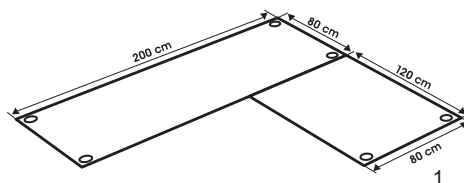

Opis	Mere Š × G × V cm	Št. za naročilo – siva / siva	Št. za naročilo – javor / srebrna
1 Kotna miza	80 × 200 × 200 × 72	WK3120200	WK7120200



SI. HP1280AH, HR350AH



SI. HP1280GR

## Pisalna miza

- Mizna plošča debeline 25 mm z robnim trakom debeline 2 mm
- 2 odprtini za kable
- Prašno lakirano T-podnožje aluminijasto-srebrne strukture
- Standardne povezovalne plošče s podporno nogo
- Noge z višinsko nastavljivimi talnimi drsniki najv. 3 cm
- Dobavljeno razstavljeno, preprosta in hitra samostojna montaža

Skladno z veljavnimi standardi je treba pri povezanih delovnih mizah znotraj ležeče noge postaviti nazaj – **Prosim, navedite to pri svojem naročilu** –

### Barve

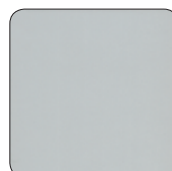

Standardni dekor siva



Standardni dekor javor



Barvne različice na koncu kataloga

### Podrobnosti



Preboj za kabel

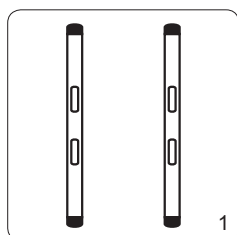

Noge, 2-krat, dolge

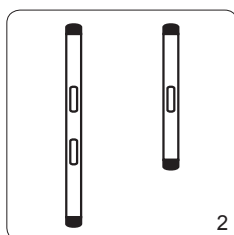

Noge, dolge / kratke

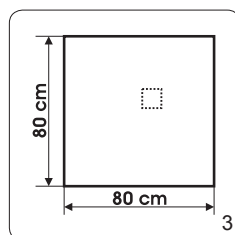

Povezovalna plošča

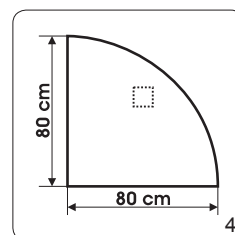

Povezovalna plošča

Opis	Mere Š × G × V cm	Št. za naročilo – siva	Št. za naročilo – javor
1 Pisalna miza – noge, 2-krat, dolge	80 × 80 × 73	HP8080GR	HP8080AH
1 Pisalna miza – noge, 2-krat, dolge	80 × 120 × 73	HP1280GR	HP1280AH
1 Pisalna miza – noge, 2-krat, dolge	80 × 160 × 73	HP1680GR	HP1680AH
2 Pisalna miza – noge dolge / kratke	80 × 80 × 73	HP8080GRK	HP8080AHK
2 Pisalna miza – noge dolge / kratke	80 × 120 × 73	HP1280GRK	HP1280AHK
2 Pisalna miza – noge dolge / kratke	80 × 160 × 73	HP1680GRK	HP1680AHK
3 Povezovalna plošča	80 × 80	HPSL808GR	HPSL808AH
4 Povezovalna plošča	80 × 80	HPCT90GR	HPCT90AH

# Pisalna miza



Sl. Z316/8384

- Mizna plošča debeline 25 mm z obrobo debeline 2 mm
- Iverna plošča kakovosti DIN EN14322:2004+2006
- Ogrodje iz jeklenih cevi 40 × 30 mm, svetlo siva
- Predal s teleskopskimi vodili
- 1 prečni ločevalnik na predal
- Centralni zaklep na cilindrično ključavnico z 2 ključema
- Dobavljeno razstavljeno, preprosta in hitra samostojna montaža
- Podkonstrukcijo lahko po želji namestite levo ali desno

PISARNA



Sl. Z312/83

## Barva



Standardni dekor  
siva

## Podrobnosti



Teleskopsko  
vodilo



Ključavnica

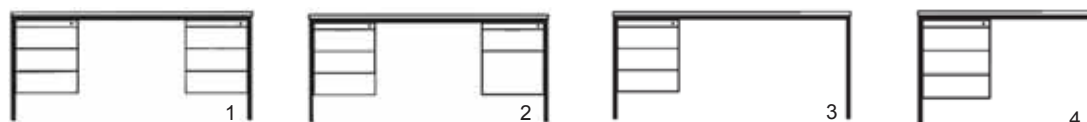

Opis	Podkonstrukcija	Mere Š × G × V cm	Lupina	Št. za naročilo
1 Pisalna miza	levo in desno 3 predali	160 × 80 × 72	MSR13/14G	<b>Z316/8383</b>
2 Pisalna miza	levo 3 predali, desno 1 obešalni del	160 × 80 × 72	MSR13/14G	<b>Z316/8384</b>
3 Pisalna miza	levo ali desno 3 predali	160 × 80 × 72	MSR13/14G	<b>Z316/83</b>
4 Pisalna miza	levo ali desno 3 predali	120 × 80 × 72	MSR13/14G	<b>Z312/83</b>



## Pisalna miza

### ročno nastavljiva po višini



SI. MG1ST356

- Miza plošča debeline 25 mm z robnim trakom debeline 2 mm
- 2 črni odprtini za kable
- Vključno s kabelskim kanalom
- Iverna plošča kakovosti DIN EN14322:2004+2006
- Prašno lakirano T-podnožje aluminijasto-srebrne strukture
- Dobavljeno razstavljeno, preprosta in hitra samostojna montaža
- Na zahtevo mogoča montirana dobava proti doplačilu



SI. MG1ST356

#### Barve



Standardni dekor siva



Standardni dekor javor



Barvne različice na koncu kataloga

#### Podrobnosti



Preboj za kabel



Nastavljivost po višini



T-noga

#### Dodatna oprema



Zaščita pred pogledi

Opis	Nastavljivost po višini	Mere Š × G cm	Zaščita pred pogledi	Št. za naročilo – javor	Št. za naročilo – siva
Pisalna miza, ročno nastavljiva po višini	62–82 cm	120 × 80	SBL91280	MG1ST728	MG1ST328
Pisalna miza, ročno nastavljiva po višini	62–82 cm	160 × 80	SBL91680	MG1ST756	MG1ST356
Pisalna miza, ročno nastavljiva po višini	62–82 cm	180 × 80	SBL91880	MG1ST718	MG1ST318

## Miza

### ročno nastavljiva po višini



SI. MG318

- Mizna plošča debeline 25 mm z obrobo debeline 2 mm
- Iverna plošča kakovosti DIN EN14322:2004+2006
- Ogrodje iz jeklenih cevi 40 × 30 mm, siva
- Dobavljeno razstavljeno, preprosta in hitra samostojna montaža



SI. MG356

#### Barva

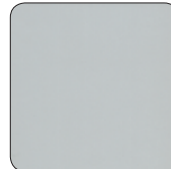

Standardni dekor  
siva

#### Podrobnosti



Podnožje



Ogrodje, sivo



SI. MG328

Opis	Nastavljivost po višini	Mere Š × G cm	Št. za naročilo – siva
Pisalna miza, ročno nastavljiva po višini	62–86 cm	120 × 80	MG328
Pisalna miza, ročno nastavljiva po višini	62–86 cm	160 × 80	MG356
Pisalna miza, ročno nastavljiva po višini	62–86 cm	180 × 80	MG318



## Pisalna miza, električno nastavljiva po višini

---

- Mizna plošča debeline 25 mm, odporna proti praskam, z robnim trakom debeline 2 mm
- Kakovost DIN EN14322:2004+2006
- Nastavitev višine poteka z dvema elektromotorčkoma, ki sta očem nevidna, saj sta vgrajena v nogah mize
- Za priklop je potreben le priključek na napetost 220/230 V.
- Dobavljeno razstavljeno v kartonih, preprosta in hitra samostojna montaža
- Vključno s kabelskim kanalom
- Na zahtevo mogoča montirana dobava proti doplačilu



Sl. EG3ST356

**Barve**

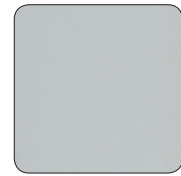

Standardni dekor siva

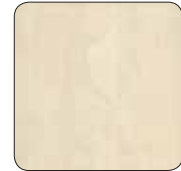

Standardni dekor javor



Barvne različice na koncu kataloga

**Podrobnosti**



Sl. EG3ST356 od spodaj



Krmiljenje navzgor / navzdol



Ogradje, beli aluminij



Preboj za kabel / kabelski kanal

**Dodatna oprema:**



Spominska tabla

Opis	Nastavljivost po višini	Mere Š × G cm	Št. za naročilo	Št. za naročilo – javor	Št. za naročilo – siva
Pisalna miza, električno nastavljiva po višini	61–125 cm	120 × 80	EG3MEMORY	EG3ST728	EG3ST328
Pisalna miza, električno nastavljiva po višini	61–125 cm	160 × 80	EG3MEMORY	EG3ST756	EG3ST356
Pisalna miza, električno nastavljiva po višini	61–125 cm	180 × 80	EG3MEMORY	EG3ST718	EG3ST318



## Predalnik

---

- Glavni del / prednji del debeline 18 mm z robnim trakom debeline 2 mm
- Vrhnji del debeline 25 mm z robnim trakom
- Jekleni predali na kotalnih vodilih, 1 predelni element na predal
- Ena posoda za pripomočke na predalnik
- Centralni zaklep na cilindrično ključavnico z 2 zložljivima ključema
- Predalnik brez koles z višinsko nastavljivimi talnimi drsniki





SI. AR480GR

SI. HR350GR

**Barve**

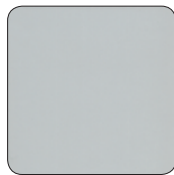

Standardni dekor siva



Standardni dekor javor

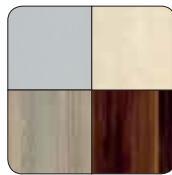

Barvne različice na koncu kataloga

**Podrobnosti**



Ključavnica



Ročaji

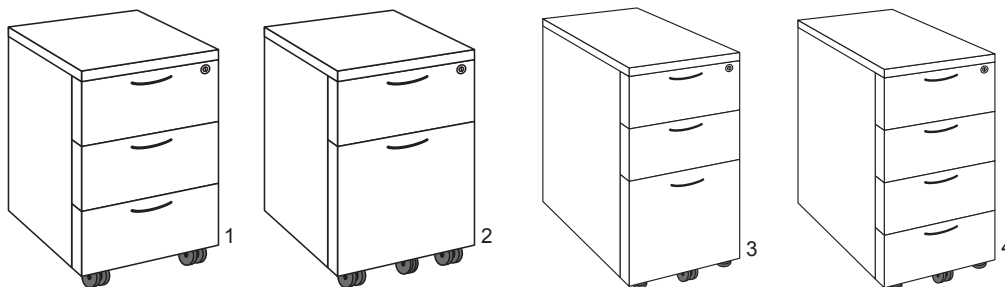

Opis	Število predalov	Mere Š × G × V cm	Št. za naročilo – siva	Št. za naročilo – javor
1 Predalnik na kolesih	3	40,5 × 50 × 59,5	HR350GR	HR350AH
2 Predalnik na kolesih	2, z obešalnim delom, ki ga lahko izvlečete	40,5 × 50 × 59,5	HR250GR	HR250AH
3 Predalnik brez koles	3, z obešalnim delom, ki ga lahko izvlečete	40 × 80 × 73	AR380GR	AR380AH
4 Predalnik brez koles	4	40 × 80 × 73	AR480GR	AR480AH



## Predalnik na kolesih



- Glavni del iz jeklene pločevine s strukturirano površino
- Centralni zaklep na cilindrično ključavnico z 2 ključema
- 4 dvojna kolesa, od tega 2 z zavorami

### Barve



Standardna barva  
RAL7035 – svetlo  
siva

RAL9005 –  
intenzivno črna

RAL9003 –  
signalno bela



Barvne različice  
na koncu kataloga

### Podrobnosti



Teleskopsko vodilo pri RC13



Leseni vrhnji del pri RC13



Kotalna vodila pri R600





Vrhnji del iz jeklene pločevine pri R600

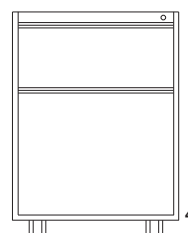
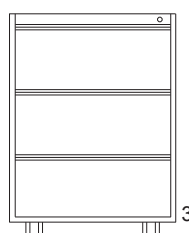
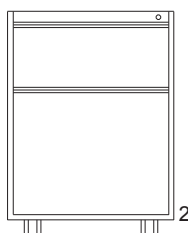
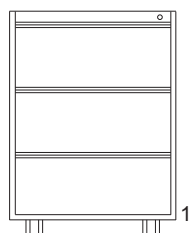

Cilindrična ključavnica



### Dodatna oprema

Opis	Izvedba	Predali	Mere Š × G × V cm	Kolesa	Lupina	Št. za naročilo
1 Predalnik na kolesih	Teleskopsko vodilo, leseni vrhnji del	3 predali	46 × 79 × 62	RC00	MSR13/14G	RC13G – siva RC13/9005 – črna RC13/9003 – bela 
2 Predalnik na kolesih	Teleskopsko vodilo, leseni vrhnji del	1 predal, 1 obešalni del	46 × 79 × 62	RC00	MSR13/14G	RC14G – siva RC14/9005 – črna RC14/9003 – bela 
3 Predalnik na kolesih	Kotalno vodilo, vrhnji del iz jeklene pločevine	3 predali	39 × 60 × 56	RC00	vsebovano	R600/01 – siva R600/9005 – črna R600/9003 – bela
4 Predalnik na kolesih	Kotalno vodilo, vrhnji del iz jeklene pločevine	1 predal, 1 obešalni del	39 × 60 × 56	RC00	vsebovano	R620/7035 – siva R620/9005 – črna R620/9003 – bela

## Design predalnik na kolesih



SI. DRC2/9005

- Eleganten videz zaradi gladke prednje strani s stranskimi ročajnimi letvami
- Glavni del iz prašno lakirane jeklene pločevine
- Izvlečna zapora, centralni zaklep na cilindrično ključavnico z 2 ključema
- 4 dvojna kolesa, od tega 2 z zavornami
- Vključno z lupino in predelnim elementom predala

### Barve



Standardna barva  
RAL7035 – svetlo  
siva



RAL9005 –  
intenzivno črna

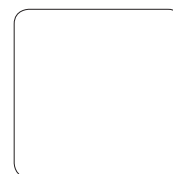

RAL9003 –  
signalno bela



RAL9006 –  
beli aluminij



Barvne različice  
na koncu kataloga

### Podrobnosti



Obešalne mape



Izvlečni element



SI. DRC2/0303

SI. DRC3/0303

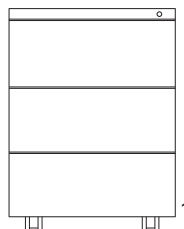

1

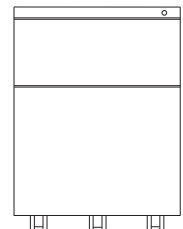

2

Opis	Predali	Mere Š × G × V cm	Št. za naročilo – siva	Št. za naročilo – črna	Št. za naročilo – signalno bela	Št. za naročilo – beli aluminij
1 Predalnik na kolesih	3 predali	39 × 59 × 56	DRC3/7035	DRC3/9005	DRC3/9003	DRC3/0303
2 Predalnik brez koles	1 predal, 1 obešalni del	39 × 59 × 56	DRC2/7035	DRC2/9005	DRC2/9003	DRC2/0303



## Kartotečna omara



SI. 3424

SI. 3404

- Robustna izvedba
- Prašno lakirana s strukturirano površino, v veliki meri odporna proti praskam
- Centralno zaklepanje na cilindrično ključavnico
- Izvlečna zapora
- Predal kot zaprta kad na teleskopskem vodilu, ki ga lahko povsem izvlečete
- 4 predali DIN A4, prečno ali pregibno

### Barva



Standardna barva  
RAL7035 – svetlo siva

### Podrobnosti



Kad



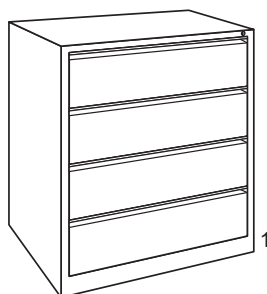

Obešalne mape

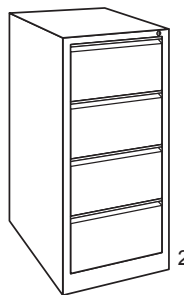

1



2

Opis	Predali	Nosilnost	Mere Š × G × V cm	Št. za naročilo
1 Kartotečna omara, dvotirna	4 predali	50 kg na predal	84 × 62 × 132,5	3424 
2 Kartotečna omara, enotirna	4 predali	30 kg na predal	46,5 × 62 × 132,5	3404 



## Kartotečna omara



SI. HSD/7035

SI. HSE/7035

- Robustna izvedba
- Prašno lakirana s strukturirano površino, v veliki meri odporna proti praskam
- Centralno zaklepanje na cilindrično ključavnico
- Izvlečna zapora
- Predal kot zaprta kad na teleskopskem vodilu, ki ga lahko povsem izvlečete
- 4 predali DIN A4, prečno ali pregibno

### Barva

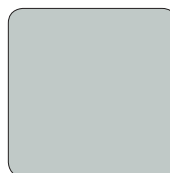

Standardna barva  
RAL7035 – svetlo  
siva



RAL9005 –  
intenzivno črna

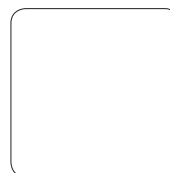

RAL9003 –  
signalno bela

### Podrobnosti



Ključavnica



Obešalne mape



Kad

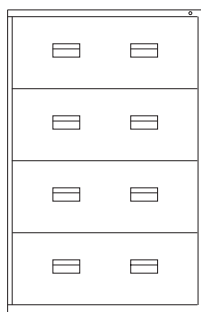

1

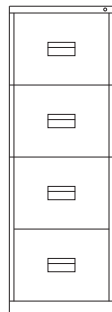

2

Opis	Nosilnost	Mere Š × G × V cm	Št. za naročilo – siva	Št. za naročilo – črna	Št. za naročilo – signalno bela
1 Kartotečna omara, dvotirna	80 kg na predal	84 × 62 × 129,5	HSD/7035	HSD/9005	HSD/9003
2 Kartotečna omara, enotirna	50 kg na predal	46,5 × 62 × 129,5	HSE/7035	HSE/9005	HSE/9003

## Univerzalni regal



SI. URG/9005

- Stranica spredaj z varovalno obrobo
- Po višini nastavljive police v razmiku 25 mm
- Police in stranski deli so prašno lakirani
- Zgoraj in spodaj zaprto
- Vključno s 4 policami
- Križna vezava za stabilizacijo
- Nosilnost posamezne police 50 kg pri enakomerno porazdeljeni obremenitvi
- Razstavljena izvedba, preprosta samostojna montaža

### Barve

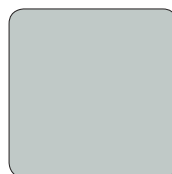

Standardna barva  
RAL7035 – svetlo  
siva



RAL9005  
– intenzivno črna

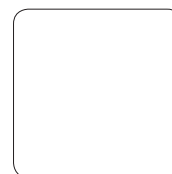

RAL9003  
– signalno bela

### Podrobnosti

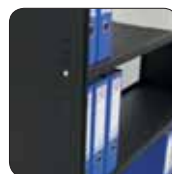

Stranske stene



Polica



Križna vezava



SI. URG/7035 + URA/7035

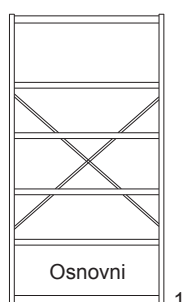

Osnovni

1

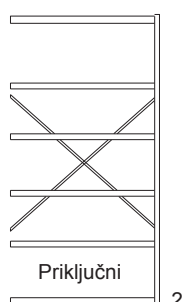

Priključni

2

Opis	Število polic	Mere Š × G × V cm	Št. za naročilo – svetlo siva	Št. za naročilo – črna	Št. za naročilo – signalno bela
1 Osnovni regal	4	96,2 × 42 × 200	URG/7035	URG/9005	URG/9003
2 Priključni regal	4	96,2 × 42 × 200	URA/7035	URA/9005	URA/9003





## Vrtljivo stojalo za registratorje

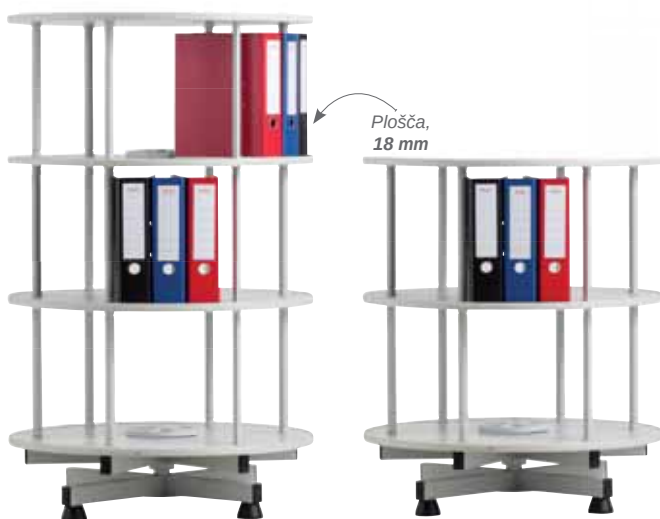

SI. OSGG/100 + OSGA/100

SI. OSGG/100

- Lahek, neslišen tek
- Lahkotno vrtenje zaradi krogelnega ležaja
- Dna etaž so iz premazanih ivernih plošč RAL7035, svetlo siva
- Stabilna jeklena konstrukcija
- Jeklena obroba preprečuje, da bi registratorji padli s stojala
- Osnovni in priključni moduli, poljubna možnost razširitve
- Dobavljeno razstavljeno, preprosta in hitra samostojna montaža

### Barva

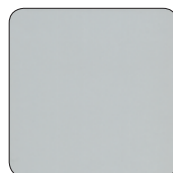

Standardni dekor siva



SI. OSEG/100 + OSEA/100

SI. OSEG/100 + OSEA/100

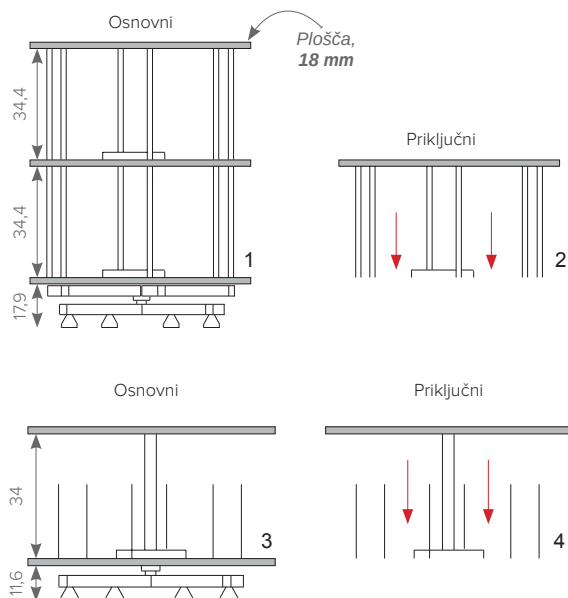

Opis	Nosilnost	Skupna nosilnost	Mere V/Ø cm	Št. za naročilo
1 Vrtljivo stojalo za registratorje – osnovni element <b>v celoti vrtljiv</b>	70 kg na etažo	300 kg	92,1/80 92,1/100	<b>OSGG/80</b> <b>OSGG/100</b>
2 Vrtljivo stojalo za registratorje – priključni element <b>v celoti vrtljiv</b>	70 kg na etažo	300 kg	36,2/80 36,2/100	<b>OSGA/80</b> <b>OSGA/100</b>
3 Vrtljivo stojalo za registratorje – osnovni element <b>posamezno vrtljiv</b>	80 kg na etažo	400 kg	49,2/80 49,2/100	<b>OSEG/80</b> <b>OSEG/100</b>
4 Vrtljivo stojalo za registratorje – priključni element <b>posamezno vrtljiv</b>	80 kg na etažo	400 kg	35,8/80 35,8/100	<b>OSEA/80</b> <b>OSEA/100</b>





## MIZE / STOLI

Trapezne mize  
Konferenčne mize  
Večnamenske mize / mize za jedilnice  
Zložljive mize  
Vrtljivi stoli / stoli  
Gardrobne klopi

MIZE /  
STOLI



## Trapezna miza

- Mizna plošča debeline 25 mm, odporna proti praskam, z robnim trakom debeline 2 mm
- Kakovost DIN 14322:2004+2006
- Jekleni okvir, prašno lakiran s strukturirano površino
- Noge z višinsko nastavljivimi talnimi drsniki
- Dobavljeno razstavljeno, preprosta in hitra samostojna montaža

Opis	Mere Š × G × V cm	Št. za naročilo. Dekor siva / siva	Št. za naročilo. Dekor javor / srebrna
Trapezna miza	60 × 120 × 72	<b>TZNG320</b>	<b>TZNG720</b>
Trapezna miza	80 × 160 × 72	<b>TZNG356</b>	<b>TZNG756</b>



SI. 2x TZNG356

### Barve

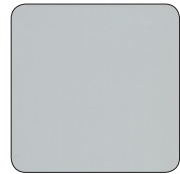

Standardni dekor  
siva

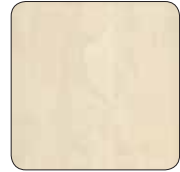

Standardni dekor  
javor

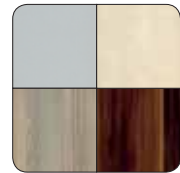

Barvne različice  
na koncu kataloga



SI. TZNG756

### Podrobnosti



Ogrodje, sivo



Ogrodje,  
beli aluminij

### Primeri postavitvev

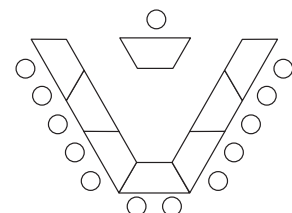
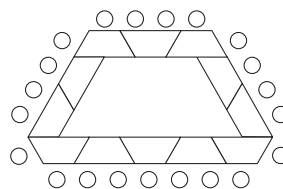
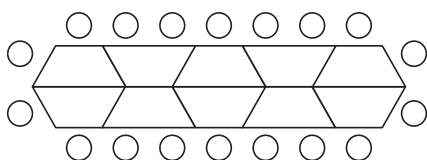
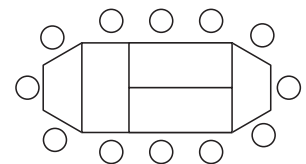
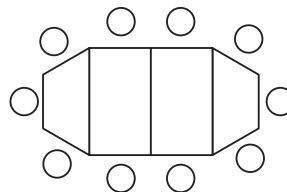
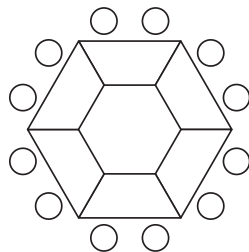
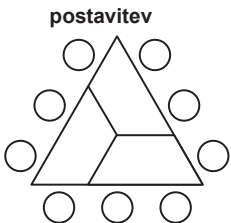

## Konferenčna miza / visoka miza



SI. BT11/7035

SI. BT07/7035

- Okrogla mizna plošča debeline 25 mm, odporna proti praskam, z robnim trakom debeline 2 mm
- Kakovost DIN EN14322:2004+2006
- Krožno podnožje
- Dobavljeno razstavljeno, preprosta in hitra samostojna montaža

### Barva

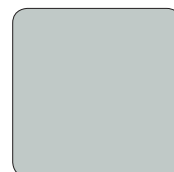

Standardni dekor  
siva



SI. 4203

## Večnamenska miza

- Mizna plošča debeline 19 mm, odporna proti praskam, z robnim trakom debeline 2 mm
- Dobavljeno razstavljeno, preprosta in hitra samostojna montaža

### Barva

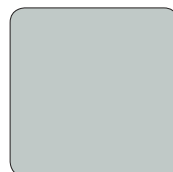

Standardni dekor  
siva

Opis	Barva	Premer	Mere Š × G × V cm	Št. za naročilo
Miza	siva / siva	100 cm	V:72/Ø:100	<b>BT07/7035</b>
Visoka miza	siva / siva	80 cm	V:110/Ø:80	<b>BT11/7035</b>
Večnamenska miza	siva / siva	-	70 × 110 × 72	<b>4203</b>
Večnamenska miza	siva / siva	-	60 × 120 × 72	<b>4204</b>



# Miza



SI. NG756

SI. NG378

- Mizna plošča debeline 25 mm, odporna proti praskam, z robnim trakom debeline 2 mm
- Kakovost DIN EN14322:2004+2006
- Jekleni okvir, praškasto lakiran s strukturirano površino
- Noge z višinsko nastavljivimi talnimi drsniki
- Dobavljeno razstavljeno, preprosta in hitra samostojna montaža

## Barve

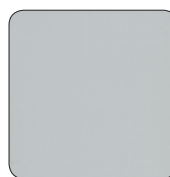

Standardni dekor siva



Standardni dekor javor

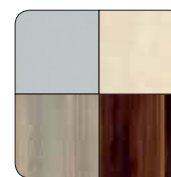

Barvne različice na koncu kataloga

## Podrobnosti



Ogrodje, sivo



Ogrodje, beli aluminij



SI. NG300

SI. NG700

Mere cm	Št. za naročilo – Dekor siva / siva, V: 72 cm	Št. za naročilo – Dekor siva / siva, V: 75 cm	Št. za naročilo – Dekor javor / srebrna, V: 72 cm	Št. za naročilo – Dekor javor / srebrna, V: 75 cm	Št. za naročilo – Siva plošča	Št. za naročilo – Plošča barve javorja
80 × 80	NG378	TG378	NG778	TG778	CPL378	CPL778
60 × 120	NG320	TG320	NG720	TG720	CPL320	CPL720
80 × 120	NG328	TG328	NG728	TG728	CPL328	CPL728
60 × 140	NG346	TG346	NG746	TG746	CPL346	CPL746
70 × 140	NG347	TG347	NG747	TG747	CPL347	CPL747
80 × 140	NG348	TG348	NG748	TG748	CPL348	CPL748
80 × 160	NG356	TG356	NG756	TG756	CPL356	CPL756
80 × 180	NG318	TG318	NG718	TG718	CPL318	CPL718
100 × 200	NG300	TG300	NG700	TG700	CPL300	CPL700

MIZE / STOLI

## Zložljiva miza

- Mizna plošča debeline 25 mm, z robnim trakom debeline 2 mm, odporna proti praskam, kakovost DIN EN14322:2004+06
- Stabilna izvedba
- Ogrodje – štiroroba cev z zložljivimi nogami mize, RAL7035 – svetlo siva, prašno lakiranje s strukturirano površino
- Zaradi prihranitve prostora razstavljeno, pakirano v kartone
- Možnost skladanja

### Barva

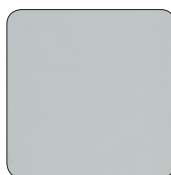

Standardni dekor  
siva

### Podrobnosti



Zložljiva  
mekanika



Ogrodje



SI. NKT356H72  
od spodaj

SI. NKT320H72  
od spodaj



SI. NKT320H72

Opis	Dekor / ogrodje	Mere Š × G cm	Št. za naročilo V: 72 cm	Št. za naročilo V: 75 cm
Zložljiva miza	siva / siva	120 × 60	NKT320H72	NKT320H75
Zložljiva miza	siva / siva	120 × 80	NKT328H72	NKT328H75
Zložljiva miza	siva / siva	140 × 70	NKT347H72	NKT347H75
Zložljiva miza	siva / siva	160 × 80	NKT356H72	NKT356H75
Zložljiva miza	siva / siva	180 × 80	NKT318H72	NKT318H75

## Zložljiva miza



SI. NKT356

- Mizna plošča debeline 25 mm, odporna proti praskam, z robnim trakom debeline 2 mm
- Kakovost DIN 14322:2004+2006
- Zložljivo ogrodje, štiroba cev, RAL7021 – črno-siva, s strukturirano površino
- Zaradi prihranitve prostora razstavljeno, pakirano v kartone
- Možnost skladanja

### Barva

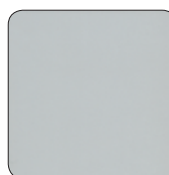

Standardni dekor  
siva



Zložljivo ogrodje



SI. NKT356 + 4 × 3014/38

Opis	Dekor / ogrodje	Mere Š × G × V cm	Št. za naročilo
Zložljiva miza	siva / črno-siva	140 × 70 × 72	<b>NKT347</b>
Zložljiva miza	siva / črno-siva	120 × 80 × 72	<b>NKT328</b>
Zložljiva miza	siva / črno-siva	160 × 80 × 72	<b>NKT356</b>
Zložljiva miza	siva / črno-siva	180 × 80 × 72	<b>NKT380</b>





Sl. 3818/38, 3819

## Ergonomski pisarniški vrtljivi stol

- Brezstopenjska nastavitev višine sedeža z mehanizmom Top-Lift
- Moderno, ergonomsko oblikovano naslonjalo z oblikovnim oblazinjenjem
- Brezstopenjsko nastavljiva višina in nagib naslonjala, udoben sedež zaradi oblikovnega oblazinjenja
- Udobna in robustna trajnostna mehanika za naslonjala, ločeno nastavljiv nagib naslonjala z ročajem
- Oblikovno lep in stabilen nožni križ, črn, dvojna kolesa z varnostnimi zavorami za trda tla
- Dobavljeno razstavljeno, preprosta in hitra samostojna montaža

### Zaščita



antracitna



modra



Sl. 3807/38

Sl. 3837/38, 3819

## Pisarniški vrtljivi stol

- Vrtljivi stol s stalnim kontaktom naslonjala pri vrtenju, nastavljiv po višini s plinskim dvigovanjem
- Brezstopenjska nastavitev naslonjala po višini, nagibu in globini
- Oblikovno lep in stabilen nožni križ s 5 kolesi za trda tla
- Dobavljeno razstavljeno, preprosta in hitra samostojna montaža

### Zaščita



antracitna

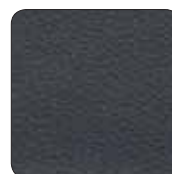

skaj



modra

Opis	Površina sedeža Š × G	Višina sedeža / celotna višina	Komplet naslonov za roke	Št. za naročilo
Pisarniški vrtljivi stol Visoko naslonjalo	44 × 46 cm	42–55/96–106 cm	3819	<b>3818/38</b> – antracitna <b>3818/06</b> – modra
Pisarniški vrtljivi stol Visoko naslonjalo	45 × 47 cm	42–55/95–108 cm	3819	<b>3837/38</b> – antracitna <b>3837/06</b> – modra <b>3837AC</b> – skaj
Pisarniški vrtljivi stol Srednje visoko naslonjalo	45 × 47 cm	42–45/86–99 cm	3819	<b>3807/38</b> – antracitna <b>3807/06</b> – modra <b>3807AC</b> – skaj





Sl. 390G22, 390P10



## Ergonomski pisarniški vrtljivi stol

- Brezstopenjska nastaviteljna višina sedeža
- Moderno, ergonomsko oblikovano naslonjalo z oblikovnim oblazinjenjem
- Brezstopenjsko nastavljljiva višina in nagib naslonjala
- Udoben sedež zaradi oblikovnega oblazinjenja
- Udobna in robustna trajnostna mehanika za nastaviteljna nagiba naslonjala
- Oblikovno lep in stabilen nožni križ, črna
- Dvojna kolesa z varnostnimi zavorami za trda tla

### Zaščita

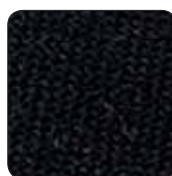

antracitna



Sl. 3350/38



## Ergonomski stol z visokim naslonjalom

- Po višini nastavljljiva naslonjala za roke
- Moderno, ergonomsko oblikovano naslonjalo
- Točkovno sinhronizirana mehanika sedeža in naslonjala
- Oblikovno lep in stabilen nožni križ, kromirana kovina
- Drsní sedež nastavljljiv glede na telesno višino
- Nastavljljivost teže, ergonomsko blazinjenje
- Primerno za 8-urni delavnik / sedenje
- Kolesa za trda tla

### Zaščita



antracitna

Opis	Površina sedeža Š × G	Višina sedeža / celotna višina	Komplet naslonov za roke	Št. za naročilo
Pisarniški vrtljivi stol z oblazinjenjem, preizkušen s strani inštituta TÜV	46 × 45 cm	42–55 / 80–103 cm	390P10	<b>390G22</b>
Pisarniški vrtljivi stol udoben	44 (h) / 50 (v) cm × 47–53	45–55 / 105–115 cm	vkjučeno	<b>3350/38</b>





SI. 3345/9911

## Ergonomski pisarniški fotelj

- Moderno, ergonomsko oblikovano naslonjalo, najlonska mreža, črna
- Oblazinjen sedež, črna barva Dralon
- Oblikovno lep in stabilen nožni križ, črna
- Nastavljiv po višini gor / dol
- Po višini nastavljiva naslonjala za roke, črna
- 2-točkovna sinhrona mehanika
- Certificirano po UNI EN 1335
- Kolesa za trda tla
- Težko vnetljiv

### Zaščita

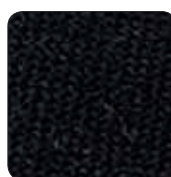

črna

MIZE /  
STOLI



SI. 3310/8811, 3310/8814

## Design prostostoječi stol

- Sedalo in naslonjalo v enem kosu
- Usnjeni videz, bela ali črna barva
- Kromirano ogrodje
- Varen pred prevrnitvijo zaradi plastičnih čepov
- Talni drsniki za trda tla

### Zaščita

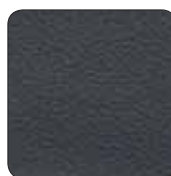

črna

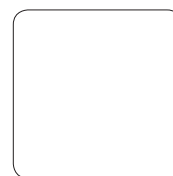

bela

Opis	Površina sedeža Š × G	Višina sedeža / celotna višina	Št. za naročilo
Pisarniški vrtljivi stol visoko naslonjalo, mreža	49 × 43 cm	44–53 / 103–112 cm	<b>3345/9911</b>
Prostostoječi stol z naslonjaloma za roke	47 × 43,5 cm	44 × 87 cm	<b>3310/8811</b> – črna <b>3310/8814</b> – bela



SI. 3340/9911

## Design stol za obiskovalce

- Zaščita sedala, črna
- Mrežno naslonjalo, črno
- Ogrodje, črno
- Možnost skladanja

### Zaščita

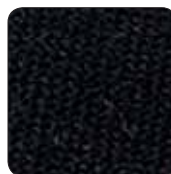

črna



SI. 3014/38

## Oblazinjen stol

- Ogrodje iz ovalne cevi, črno
- Oblazinjeno sedalo in naslonjalo
- Možnost skladanja

### Zaščita



antracitna

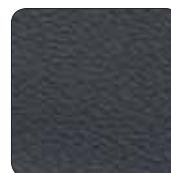

skaj



modra

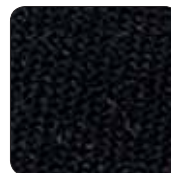

črna

Opis	Površina sedeža Š × G	Višina sedeža / celotna višina	Št. za naročilo
Design stol za obiskovalce Mrežno naslonjalo Možnost skladanja	45 × 45 cm	40/80 cm	<b>3340/9911</b>
Oblazinjen stol Možnost skladanja	46 × 45 cm	40/80 cm	<b>3014/38</b> – antracitna <b>3014AC</b> – skaj <b>3014/06</b> – modra <b>3014/11</b> – črna



Sl. 3008G



Sl. 3007G

## Stol z možnostjo skladanja

- Ogrodje iz okrogle cevi premera 21 mm, svetlo siva, prašno lakirana
- Sedalo in naslonjalo iz večkrat zlepljenega vezanega lesa (8 mm)
- Manj izgub zaradi notranjih zatičev na nogah
- Možnost skladanja

- Ogrodje svetlo sivo, s praškastim lakom
- Sedalo in naslonjalo iz večkrat zlepljenega vezanega lesa
- Manj izgub zaradi notranjih zatičev na nogah
- Možnost skladanja

### Ogrodje

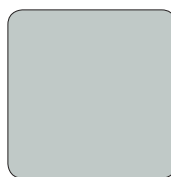

RAL7035 – svetlo siva

MIZE /  
STOLI

## Stol z leseno sedežno lupino z možnostjo skladanja

- Sedalo in naslonjalo v enem kosu
- Bukev, lakirano
- Ogrodje iz kroma, 18 mm
- Z možnostjo vezave v vrsto
- Možnost skladanja

### Ogrodje

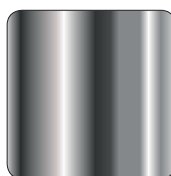

Krom



Sl. 3009CR

Opis	Ogrodje	Površina sedeža Š × G	Višina sedeža / celotna višina	Št. za naročilo
Lesen stol z možnostjo skladanja	siva	39,5 × 38 cm	49,5 × 83 cm	3008G 
Lesen stol z možnostjo skladanja	siva	37,5 × 38 cm	44,0 × 79,5 cm	3007G
Stol z leseno sedežno lupino z možnostjo skladanja	krom	43,5 × 42 cm	45,0 × 86 cm	3009CR



SI. 3002/HSN

## Stol z možnostjo skladanja

- Ogradje iz okrogle cevi, 18 mm
- Tolčeni vzorec lakiranja
- Lupina iz nezlomljive plastike, antracitna

### Barva

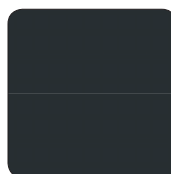

črna

### Ogradje



Tolčeni vzorec lakiranja, črna



SI. 3002/01N

## Stol z možnostjo skladanja

- Ogradje iz okrogle cevi, 18 mm, praškasti lak, svetlo siva
- Lupina iz nezlomljive plastike, antracitna

### Barva

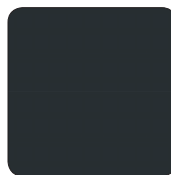

črna



modra

### Ogradje

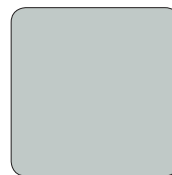

RAL7035 – svetlo siva

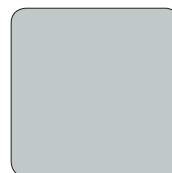

RAL7035 – svetlo siva

Opis	Lupina	Ogradje	Površina sedeža Š × G	Višina sedeža / celotna višina	Št. za naročilo
Stol z možnostjo skladanja	antracitna	Tolčeni vzorec lakiranja	43,5 × 42 cm	45/81 cm	3002/HSN
Stol z možnostjo skladanja	antracitna	siva	43,5 × 42 cm	45/81 cm	3002/01N
Stol z možnostjo skladanja	modra	siva	43,5 × 42 cm	45/81 cm	3002/06N



SI. 24150KSD

## Klop

- Z garderobnimi letvami in rešetkami za čevlje
- Trdna, stabilna izvedba
- Enostranska in dvostranska
- Prašno lakirana s strukturirano površino
- Opremljena s premazanimi in lakiranimi lesenimi letvami
- Celotne enote so opremljene z aluminijastimi obešali za oblačila
- Dobavljeno razstavljeno, preprosta in hitra samostojna montaža

### Ogrodje

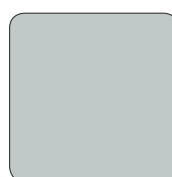

RAL7035 – svetlo siva

MIZE /  
STOLI



SI. 24160G

## Garderobna klop

- Ogrodje iz štirirobe cevi 30 × 30 mm, svetlo siva
- Sedalo iz masivnih letev iz trdega lesa
- Dobavljeno razstavljeno, preprosta in hitra samostojna montaža

### Ogrodje

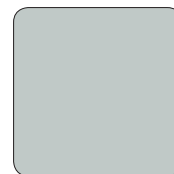

RAL7035 – svetlo siva

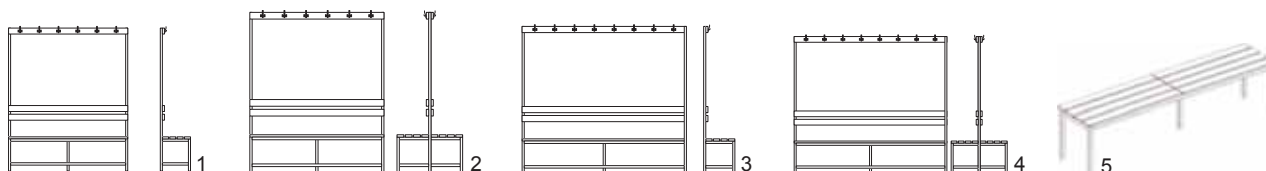

Opis	Obešalo	Mere Š × G × V cm	Št. za naročilo
1 Klop, enostranska	6	150 × 38 × 180	<b>24150KSE</b>
2 Klop, dvostranska	12	150 × 73 × 180	<b>24150KSD</b>
3 Klop, enostranska	8	200 × 38 × 180	<b>24200KSE</b>
4 Klop, dvostranska	16	200 × 73 × 180	<b>24200KSD</b>
5 Garderobna klop	-	120 × 38 × 45	<b>24120G</b>
5 Garderobna klop	-	160 × 38 × 45	<b>24160G</b>
5 Garderobna klop	-	200 × 38 × 45	<b>24200G</b>







## POHIŠTVO

Postelje  
Omare / pisalne mize  
Regali / komode  
Mize / obešala za oblačila  
Pogradi / vzmetnice  
Posteljina / drugo

BIVANJE



SI. 1015AH

## Postelja z zaprtim okvirjem

- Stranice debeline 18 mm z robnim trakom debeline 2 mm
- Nastavljivi vijaki za prilagoditev
- Priložen robusten kovinski posteljni okvir s 14 upogljivimi lesenimi letvami in 2 prečnima opornikoma
- Dobavljeno razstavljeno, preprosta in hitra samostojna montaža

### Barve



Standardni dekor javor

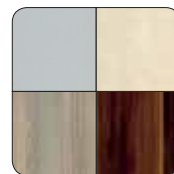

Barvne različice na koncu kataloga

## Lesena nočna omarica

- Dekor javor
- 1 predal, 1 odprt prekat
- Nastavljivi vijaki za prilagoditev



SI. 1061AH



Sl. 1012TW

## Lesena postelja z letvenim dnom

- 4 kovinske noge
- Priloženo zložljivo posteljno dno z ravnimi letvami
- Zelo visoka nosilnost
- Dobavljeno razstavljeno, preprosta in hitra samostojna montaža



Sl. 1051T

Sl. 1051STW

## Lesena nočna omarica

- Model z ali brez belega predala
- Bel predalnik na kotalnih vodilih

### Barve

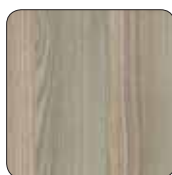

Standardni dekor toledo

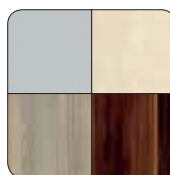

Barvne različice na koncu kataloga

Opis	Barva	Mere Š × G × V cm	Št. za naročilo
Lesena postelja	javor	90 × 200	1015AH
Nočna omarica	javor	60 × 40 × 45	1061AH
Lesena postelja	toledo / bela	90 × 200 × 59	1012TW
Nočna omarica, brez predalov	toledo	45 × 35 × 46	1051T
Nočna omarica, 1 predal, bela	toledo / bela	45 × 35 × 46	1051STW

## Lesena omara za oblačila / perilo

- Stranice / vrata debeline 18 mm z robnim trakom debeline 2 mm
- Zadnja stena debeline 8 mm
- Zgornji in spodnji del ter police debeline 25 mm z robnim trakom debeline 2 mm
- Okovje in tečajji v stabilni kovinski izvedbi
- Police različno nastavljive
- Dobavljeno razstavljeno, preprosta in hitra samostojna montaža

### Barve



Standardni dekor javor



Standardni dekor toledo

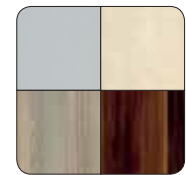

Barvne različice na koncu kataloga

### Podrobnosti



Zapah



Ročajji in ključavnica



Tečaj od znotraj



Obešalni drog, kavliji

### Dodatna oprema



Kovinska ključavnica



SI. 1010TW

SI. 1010AH

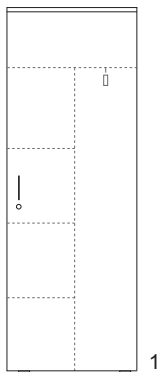

1

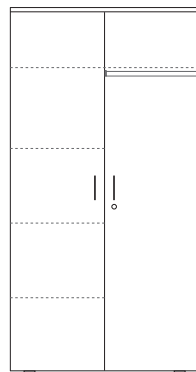

2

Opis	Vrata	Ključavnica	Mere Š × G × V cm	Št. za naročilo – javor	Št. za naročilo – toledo / bela
1 Omara za oblačila / perilo	1	1 kovinska ključavnica	60 × 50 × 180	1008AH	1008TW
2 Omara za oblačila / perilo	2	1 kovinska ključavnica	90 × 50 × 180	1010AH	1010TW

## Lesena pisalna miza



SI. 503AH

- Mizna plošča debeline 25 mm z robnim trakom debeline 2 mm
- 2 odprtini za kable
- Noge z višinsko nastavljivimi talnimi drsniki
- Podkonstrukcija z 2 predaloma
- Dobavljeno razstavljeno, preprosta in hitra samostojna montaža

### Barve



Standardni dekor  
javor

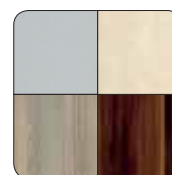

Barvne različice  
na koncu kataloga

## Lesena pisalna miza



SI. 502TW

- Mizna plošča debeline 18 mm z robnim trakom debeline 2 mm
- Kovinska noga 5 × 2,5 cm – belo lakirana
- Delovna površina in stranski deli iz lesa
- Noge z višinsko nastavljivimi talnimi drsniki
- Dobavljeno razstavljeno, preprosta in hitra samostojna montaža

### Barve



Standardni dekor  
toledo



Barvne različice  
na koncu kataloga

Opis	Barva	Posebnost	Mere Š × G × V cm	Št. za naročilo
Lesena pisalna miza	javor	2 predala	110 × 60 × 73	<b>503AH</b>
Lesena pisalna miza	toledo / bela	1 predal, bel	80 × 60 × 72	<b>502TW</b>





SI. SR100T

## Leseni regal za knjige

- Hrbtišče debeline 18 mm z robnim trakom debeline 2 mm
- Police debeline 18 mm
- 4 stranski elementi 9 × 1,8 cm
- 5 polic
- 3 elementi na hrbtni strani
- Noge z višinsko nastavljivimi talnimi drsniki
- Dobavljeno razstavljeno, preprosta in hitra samostojna montaža

### Barve

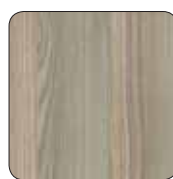

Standardni dekor toledo

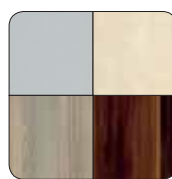

Barvne različice na koncu kataloga

## Lesena komoda



SI. 1044TW

- Zgornja in spodnja plošča debeline 18 mm z robnim trakom debeline 2 mm
- Predali s teleskopskimi vodili
- 4 kovinske noge
- Robustna izvedba
- Komoda je dobavljiva sestavljena, priviti je treba noge in ročaje

### Barve



Standardni dekor toledo

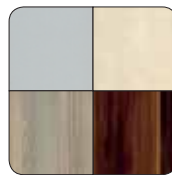

Barvne različice na koncu kataloga

Opis	Posebnost	Barva	Mere Š × G × V cm	Št. za naročilo
Regal za knjige	-	toledo	100 × 25 × 180	<b>SR100T</b>
Komoda	4 predali	toledo / bela	90 × 45 × 108	<b>1044TW</b>



## Miza



Sl. NG978W

- Mizna plošča debeline 25 mm, odporna proti praskam, z robnim trakom debeline 2 mm
- Kakovost DIN EN14322:2004+2006
- Jekleni okvir, prašno lakiran s strukturirano površino
- Ogrodje v barvi RAL9006, beli aluminij
- Noge z višinsko nastavljivimi talnimi drsniki
- Dobavljeno razstavljeno, preprosta in hitra samostojna montaža

### Barve



Standardni dekor  
bela



Standardni dekor  
toledo

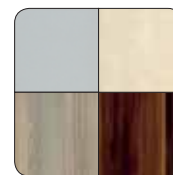

Barvne različice  
na koncu kataloga

## Letev z obešali za oblačila

- 4 obešala



Sl. 9505T

### Barve



Standardni dekor  
toledo

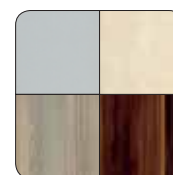

Barvne različice  
na koncu kataloga

Opis	Barva	Mere Š × G × V cm	Št. za naročilo
Miza	Ogrodje: beli aluminij Plošča: toledo	80 × 80 × 72	NG978T
Miza	Ogrodje: beli aluminij Plošča: bela	80 × 80 × 72	NG978W
Letev s 4 obešali za oblačila	toledo	50 × 1,8 × 10	9505T



## Varnostni pograd

- Vzglavje in podnožje iz okrogle jeklene cevi premera 40 mm
- Robustno jekleno mrežasto dno s 3 prečnimi oporniki
- Vsi kovinski deli prašno lakirani v srebrni barvi
- Deljiv v 2 enojni postelji
- Nosilnost: 150 kg na ležišče
- Privita zaščita pred dvigovanjem

### Barva



RAL9006  
– beli aluminij

### Dodatna oprema

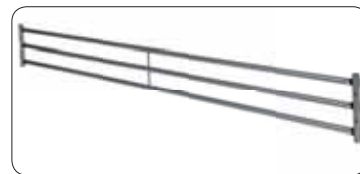

Zadnje varovalo pred padcem



Sl. 5100S + 5140S



### Podrobnosti



Prečke okvirja



Sistem natikanja



Varovalni zatič ščiti pred dvigovanjem zgornje postelje

## Kovinska nočna omarica

- 1 predal,  
2 odprta prekata

### Barva

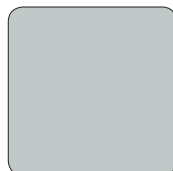

RAL7035 – svetlo siva



Sl. M1051

Opis	Mere Š × G × V cm	Varnostni paket (lestev + prednje varovalo pred padcem)	Zadnje varovalo pred padcem	Št. za naročilo
Pograd z mrežastim dnom	90 × 200	5140S	5150S	<b>5100S</b>
Kovinska nočna omarica	40 × 50 × 50	-	-	<b>M1051</b>

## Kovinski pograd



Sl. 5020

- Vzglavje in podnožje iz okrogle jeklene cevi
- Trpežen okrogli profil
- Ležišče z mrežastim dnom
- Prašno lakirano v rjavi
- Deljiv v 2 enojni postelji
- Nosilnost: 140 kg na ležišče
- Staknjeno

### Barve



RAL8017  
– čokoladno rjava

### Podrobnosti



Prečke okvirja



Sistem natikanja



Varovalni zatič ščiti pred dvigovanjem zgornje postelje

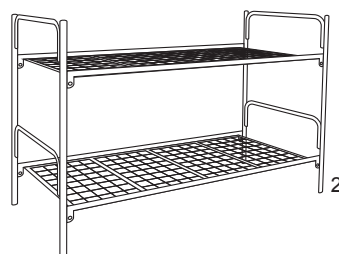
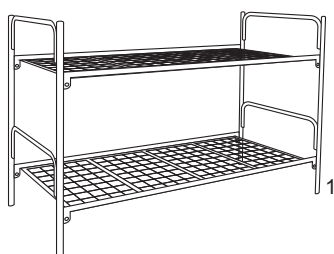

### Dodatna oprema



Varnostni paket

	Opis	Mere Š × G × V cm	Varnostni paket (lestev + prednje varovalo pred padcem)	Št. za naročilo
1	Pograd z mrežastim dnom	80 × 190	5542	5019
2	Pograd z mrežastim dnom	90 × 190	5542	5020

## Osnovno penasto ležišče (7051, 7054, 7058, 7060, 7062)



Sl. 7051, 7060

- 1-delno iz poliuretanske pene
- Modra prevleka z zadrgo
- Pralna pri temperaturi do 60 °C
- Gostota RG20- 22

## Penasto ležišče Premium (7070WR, 7080WR)



Sl. 7070WR, 7080WR

- 1-delno iz poliuretanske pene
- Raztegljiva prevleka z zadrgo
- Pralna pri temperaturi do 60 °C
- Gostota RG30

Opis	Mere Š × G cm	Višina v cm	Št. za naročilo
Penasto ležišče	80 × 190	8	<b>7051</b>
Penasto ležišče	80 × 190	10	<b>7054</b>
Penasto ležišče	90 × 190	8	<b>7058</b>
Penasto ležišče	90 × 190	10	<b>7060</b>
Penasto ležišče	90 × 200	10	<b>7062</b>
Penasto ležišče RG30	90 × 190	10	<b>7070WR</b>
Penasto ležišče RG30	90 × 200	10	<b>7080WR</b>

## Vzmetnica (7500, 7600)



Sl. 7500

- 1-delno ležišče z vzmetnim jedrom Bonell
- Obojestranska ojačitev oblazinjenja
- Prešita zgornja stran
- Spodnja stran z gladko prevleko

## Univerzalna zaščita za vzmetnico



Sl. 8380

- Zaščita za vzmetnico, prevleka za letveno dno
- Iglana klobučevina iz jute
- Vrhnji del iz bele viskoze, ojačitev s sintetičnim materialom
- Obojestransko ojačana
- Obstojna proti obrabi
- Zračna
- Obrobljena

Opis	Mere Š × G cm	Višina v cm	Št. za naročilo
Vzmetnica	90 × 190	14	<b>7500</b>
Vzmetnica	90 × 200	14	<b>7600</b>
Zaščita za vzmetnico	75 × 190	-	<b>8380</b>



Sl. 6145, 6148S

## Sintetičen vzglavnik

- Zaščita iz zračne bombažne tkanine
- Polnilo iz 100-odstotnega gostega poliestra bele barve
- Pralna pri temperaturi do 60 °C



Sl. 6020

## Sintetična prešita odeja

- Prevleka Fibranne uni natur
- 70-odstotni poliester, 30-odstotni bombaž
- Polnilo 100-odstotni poliester
- Obroba iz karo prešitja
- Pralna pri temperaturi do 60 °C



Sl. 6006

## Odeja iz flisa

- Različni potiski
- Pralna pri temperaturi do 40 °C

Opis	Mere Š × G cm	Teža	Št. za naročilo
Vzglavnik	50 × 60	Teža polnila: pribl. 450 g	<b>6145</b>
Vzglavnik	80 × 80	Teža polnila: pribl. 850 g	<b>6148S</b>
Prešita odeja	135 × 200	pribl. 1100 g	<b>6020</b>
Odeja iz flisa	150 × 200	pribl. 800 g	<b>6006</b>





Sl. Posteljna garnitura 2

## Posteljna garnitura

- Pakirano brez embalaže
- Vključuje:
  - 1 × vzglavnik 80 × 80 cm – št. za naročilo **6148S**
  - 1 × odeja 135 × 200 – št. za naročilo **6020**
  - 2 × posteljina – št. za naročilo **8055**
  - 2 × rjuha – št. za naročilo **8094**
- Izdelki, kot navedeno spodaj

## Komplet posteljnine

- Poliester
- 2-delni
- Modro-belo karirast vzorec
- Pralna pri temperaturi do 60 °C



Sl. 8001/8011



Sl. 8055

## Komplet posteljnine

- 2-delni
- Poliester
- Potiski različnih barv, pomešani v kartonu
- Pralna pri temperaturi do 60 °C

## Napenjalna rjuha

- Različne barve
- Pralna pri temperaturi do 60 °C



Sl. 8094

Opis	Mere Š × G cm	Št. za naročilo
Komplet za spanje vključuje: 1 × 6148S, 1 × 6020, 2 × 8055, 2 × 8094		<b>Posteljna garnitura 2</b>
Komplet posteljnine Posteljina	Vzglavnik 50 × 60 Prevleka 135 × 200	<b>8001/8011</b>
Komplet posteljnine Posteljina	Vzglavnik 80 × 80 Prevleka 135 × 200	<b>8055</b>
Rjuha (različne barve)		<b>8094</b>



## Koš za smeti (9769)

- Umetna masa
- Črn

SI. 9769



## Koš za smeti s stopalko (9701)

- Z vložkom iz umetne mase
- Jeklena pločevina, prevlečena z umetno maso
- Srebrn

SI. 9701



## Mrežast koš za smeti (9751)

- Črn

SI. 9751



## Koš za smeti s pepelnikom (9704)

- nerjavno jeklo

SI. 9704

Opis	Barva	Mere v cm	Št. za naročilo
Koš za smeti VE, 30 kosov	črna	Višina: 30 Ø: 27	9769
Koš za smeti s stopalko 12 litrov	srebrn	Višina: 39,5 Ø: 25,5	9701
Mrežast koš za smeti	črna	Višina: 35,5 Ø: 29,5	9751
Pepelnik	nerjavno jeklo	Višina: 60 Ø: 25	9704



Sl. GS/130

## Garderobno stojalo (GS/130)

- črno z držalom za dežnike



Sl. GS/02

## Garderobno stojalo (GS/02)

- črno z držalom za dežnike in posodico za prestrezanje



Sl. 9505

## Letev z obešali za oblačila (9505)

- Masivni les s 5 obešali

Opis	Št. za naročilo
Garderobno stojalo	GS/130
Garderobno stojalo	GS/02
Letev z obešali za oblačila 5 obešal	9505



## Hladilnik (9102)



SI. 9102

- 70 litrov
- Energetski razred A+
- Brez zamrzovalnega predala
- 1 predal za zelenjavo
- Vrata s prevleko iz umetne mase bele barve
- Emajlirane stranice bele barve

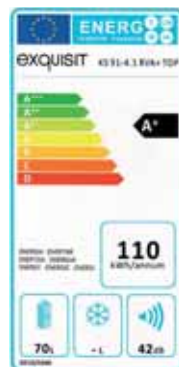

SI. 9104L

## Kombinirana kuhinja (9104L, 9104R)

- Gornji del vključuje naslednje:  
prekrivna plošča iz nerjavečega jekla,  
pomivalno korito z odtočno garnituro,  
običajna plošča 1500 W, hitra plošča  
1500 W
- Spodnji del vključuje naslednje:  
hladilnik s prostornino 81 litrov,  
energetski razred A+, zamrzovalnik  
z 2 zvezdicama, prostoren odlagalni  
predal, montiran
- Brez armature





## Dvojna kuhalna plošča (9101)



Sl. 9101

- Običajna plošča, 15 cm, 1000 W, hitra plošča, 18 cm, 1500 W, 2 brezstopenjsko nastavljiva termostata, 2 kontrolni lučki, barva, odporna na toploto, bela, visoka stabilnost
- Električno napajanje: 230 V, 50 Hz, 2500 W

Opis	Mere Š × G × V cm	Št. za naročilo
Hladilnik brez zamrzovalnega predala	48 × 43 × 85	9102 
Kombinirana kuhinja	100 × 60 × 90	9104L – umivalnik levo 9104R – umivalnik desno
Dvojna kuhalna plošča	48 × 29 × 7,5	9101 

### KUHINJA / DRUGO

Električne naprave

KUHINJA



## Barvne različice

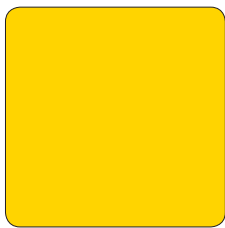

RAL 1018

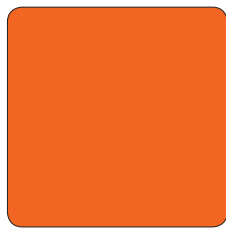

RAL 2004

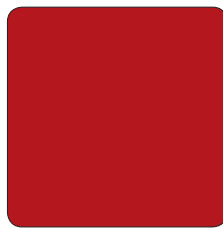

RAL 3000



RAL 5010

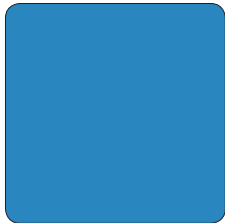

RAL 5012

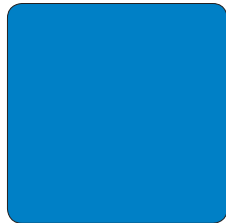

RAL 5015

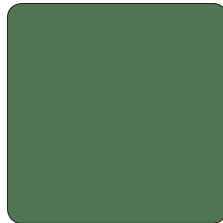

RAL 6011

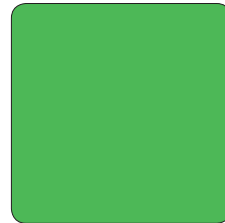

RAL 6018

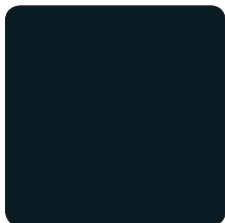

RAL 7021

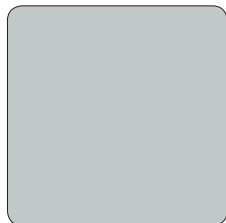

RAL 7035

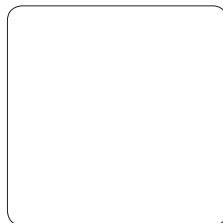

RAL 9003

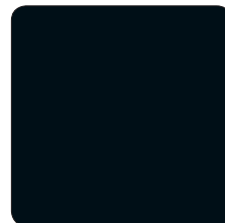

RAL 9005



RAL 9006

Za vse posebne barve velja: najmanjša količina in rok dobave na zahtevo





## Dekorativne možnosti



bela

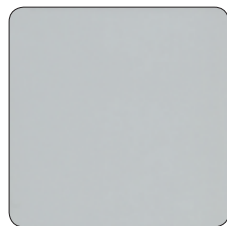

siva

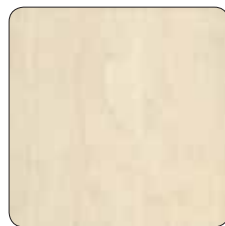

javor



sliva, svetla

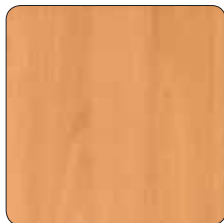

bukev



toledo



sliva, temna

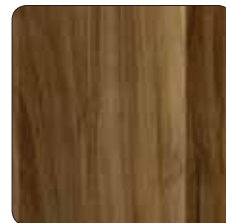

oreh

Za vse posebne dekorje velja: najmanjša količina in rok dobave na zahtevo

# Izvedbe ključavnic



## Cilindrična ključavnica za številko artikla:

202SM0101, 21PSM0101, 121SM0101, 253SM0101, 52PSM0101, 24PSM0101, 23PSM0101, K41SM0101, K82SM0101, K12SM0101, 211SM0101, 212SM0101, 213SM0101, 214SM0101, 231SM0101, 232SM0101, 233SM0101, C3210101, C3310101, 2040, 2080, 2120, Z415, Z800, Z120, 905SM0101, 910SM0101, S05SM0101, S10SM0101, S15SM0101, S04SM0101, S08SM0101, S12SM0101, 272SM0101, 274SM0101, 276SM0101, FST4ZY, FWT4ZY, DCH18012, DCH18024, DCH18011, DCH18022, CB10/7035, CB10T5010, CB10T3000, CB10T7016, CB11/7035, CB11T5010, CB11T3000, CB11T7016, CB12/7035, CB12T5010, CB12T3000, CB12T7016, 503AH

ZY20



## Zaklep z vrtljivim kovinskim zapahom za številko artikla:

202SM0101, 21PSM0101, 121SM0101, 253SM0101, 52PSM0101, 24PSM0101, 23PSM0101, K41SM0101, K82SM0101, K12SM0101, 211SM0101, 212SM0101, 213SM0101, 214SM0101, 231SM0101, 232SM0101, 233SM0101, C321SM0101, C331SM0101, 2040, 2080, 2120, Z415, Z800, Z120, 905SM0101, 910SM0101, S05SM0101, S10SM0101, S15SM0101, S04SM0101, S08SM0101, S12SM0101, 272SM0101, 274SM0101, 276SM0101, FST4, FWT4, DCH18012, DCH18024, DCH18011, DCH18022

MR20 = desna vrata  
MR20L = leva vrata

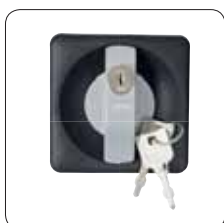

## Ključavnica za omaro s krilnimi vrati:

2297, 2297VZ, 2297AK, 2296, 2296AK, 2295, 2294, 2290/0101, 2292, 2292/60, 2293, US92/0101

NZY

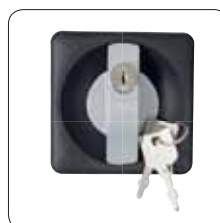

## Ključavnica za omaro s krilnimi vrati, identični ključi:

2297, 2297VZ, 2297AK, 2296, 2296AK, 2295, 2294, 2290/0101, 2292, 2292/60, 2293, US92/0101

NZYGLEICH



## Glavni ključ za omaro s krilnimi vrati:

2297, 2297VZ, 2297AK, 2296, 2296AK, 2295, 2294, 2290/0101, 2292, 2292/60, 2293, US92/0101

Glavni ključ



## Glavni ključ za ključavnice:

Primeren za št. izdelkov:  
glej ZY20, RZY

Glavni ključ



## Ključavnica za omaro z drsnimi vrati:

ST3D01, ST2D01

DZYD



## Ključavnica za ognjevarno omaro:

SD01/1601, SD02/1601

FZYD



## Slepi ključ za ognjevarno omaro:

SD01/1601, SD02/1602

Slepi ključ

Za vse ključavnice in ključe velja: najmanjša količina in rok dobave na zahtevo



ZYRS

**Ključavnica za omare:**

RS02/7035, RS03/7035, RS05/7035, RS02/9005, RS03/9005, RS05/9005, RS02/9003, RS03/9003, RS05/9003



RZY

**Ključavnica za omare:**

HSE/7035, HSE/9005, HSE/9003. HSD/7035, HSD/9005, HSD/9003, 3404, 3424, DRC3/0303, DRC2/0303, DRC3/9005, DRC3/9003, DRC2/9005, DRC2/9003, DRC2/7035, DRC3/7035, UB83/0101, UB84/0101, R600/01, R620/01, R600/9005, R600/9003, R620/9005, R620/9003, RC13G, RC13/9005, RC13/9003, RC14G, RC14/9005, RC14/9003



SZY

**Ključavnica za leseno omaro z drsnimi vrati:**

SSOH2GR, SSOH2AH, SSOH3GR, SSOH3AH



HZY

**Ključavnica za lesene predalnice na kolesih:**

HR250GR, HR250AH, HR350GR, HR350AH, AR380GR, AR380AH, AR480GR, AR480AH



HKZY

**Ključavnica za lesene garderobne omare:**

ST80OH2GR, ST80OH2AH, ST80OH3GR, ST80OH3AH, ST80OH4GR, ST80OH4AH, ST80OH5GR, ST80OH5AH, ST80OH6GR, ST80OH6AH, 1008AH, 1008TW, 1010AH, 1010TW



VS

**Obešanka s premerom stremena 5 mm za omaro:**

202SM0101, 21PSM0101, 121SM0101, 253SM0101, 52PSM0101, 24PSM0101, 23PSM0101, K41SM0101, K82SM0101, K12SM0101, 211SM0101, 212SM0101, 213SM0101, 214SM0101, 231SM0101, 232SM0101, 233SM0101, C3210101, C3310101, 2040, 2080, 2120, Z415, Z800, Z120, 905SM0101, 910SM0101, S05SM0101, S10SM0101, S15SM0101, S04SM0101, S08SM0101, S12SM0101, 272SM0101, 274SM0101, 276SM0101, DCH18012, DCH18024, DCH18011, DCH18022



VSHZ

**Numerična obešanka s premerom stremena 5 mm za omaro:**

202SM0101, 21PSM0101, 121SM0101, 253SM0101, 52PSM0101, 24PSM0101, 23PSM0101, K41SM0101, K82SM0101, K12SM0101, 211SM0101, 212SM0101, 213SM0101, 214SM0101, 231SM0101, 232SM0101, 233SM0101, C3210101, C3310101, 2040, 2080, 2120, Z415, Z800, Z120, 905SM0101, 910SM0101, S05SM0101, S10SM0101, S15SM0101, S04SM0101, S08SM0101, S12SM0101, 272SM0101, 274SM0101, 276SM0101, DCH18012, DCH18024, DCH18011, DCH18022





IP17/18

